



This is a chapter from the book

System Design, Modeling, and Simulation using Ptolemy II

This work is licensed under the Creative Commons Attribution-ShareAlike 3.0 Unported License. To view a copy of this license, visit:

<http://creativecommons.org/licenses/by-sa/3.0/>,

or send a letter to Creative Commons, 444 Castro Street, Suite 900, Mountain View, California, 94041, USA. Permissions beyond the scope of this license may be available at:

<http://ptolemy.org/books/Systems>.

First Edition, Version 1.0

Please cite this book as:

Claudius Ptolemaeus, Editor,
System Design, Modeling, and Simulation using Ptolemy II, Ptolemy.org, 2014.
<http://ptolemy.org/books/Systems>.

Building Graphical Models

Christopher Brooks, Edward A. Lee, Stephen Neuendorffer, and John Reekie

Contents

2.1	Getting Started	39
2.1.1	Executing a Pre-Built Signal Processing Example	39
2.1.2	Creating and Running a Model	45
2.1.3	Making Connections	47
	<i>Sidebar: Sources Library</i>	48
	<i>Sidebar: Sinks Library</i>	49
2.2	Tokens and Data Types	52
	<i>Sidebar: Math Library</i>	57
	<i>Sidebar: Math Library (Continued)</i>	58
2.3	Hierarchy and Composite Actors	59
2.3.1	Adding Ports to a Composite Actor	60
2.3.2	Setting the Types of Ports	62
2.3.3	Multiports, Busses, and Hierarchy	64
2.4	Annotations and Parameterization	65
2.4.1	Parameters in Hierarchical Models	65
2.4.2	Decorative Elements	68
2.4.3	Creating Custom Icons	68
2.5	Navigating Larger Models	68
2.6	Classes and Inheritance	71
2.6.1	Overriding Parameter Values in Instances	75

2.6.2	Subclasses and Inheritance	76
2.6.3	Sharing Classes Across Models	77
2.7	Higher-Order Components	79
2.7.1	MultiInstance Composite	81
2.7.2	IterateOverArray	84
2.7.3	Lifecycle Management Actors	86
	<i>Sidebar: Array Construction and Deconstruction Actors</i>	<i>86</i>
2.8	Summary	87
	<i>Sidebar: Array Manipulation Actors</i>	<i>88</i>
	<i>Sidebar: Mobile Code</i>	<i>89</i>

This chapter provides a tutorial on constructing Ptolemy II simulation models using **Vergil**, the Ptolemy graphical user interface (**GUI**). Figure 2.1 shows a simple Ptolemy II model in Vergil. This model is shown in the graph editor, one of several possible entry mechanisms available in Ptolemy II. It is also possible, for example, to define models in Java or XML.

2.1 Getting Started

Executing the examples in this chapter requires installation of Ptolemy II¹. Once it is installed, you will need to invoke Vergil, which will display the initial welcome window shown in Figure 2.2. The “Tour of Ptolemy II” link takes you to the page shown in Figure 2.3.

2.1.1 Executing a Pre-Built Signal Processing Example

On the “Tour of Ptolemy II” page, the first example listed under “Basic Modeling Capabilities” (Spectrum), is the model shown in Figure 2.1. This model creates a sinusoidal signal, multiplies it by a sinusoidal carrier, adds noise, and then estimates the power spectrum. This model can be executed using the run button in the toolbar (the blue triangle

¹See <http://ptolemy.org/ptolemyII/ptIIlatest> for the latest release, and <http://chess.eecs.berkeley.edu/ptexternal/> for access to the ongoing development version. Alternatively, most of the figures in this book have an online version of the model that you can browse using any web browser. More interestingly, if you are reading this book on a Java-capable machine, you can also follow a link that uses Java **Web Start** to launch Vergil without any explicit installation step. You can browse, edit, and execute models, and also save them to local disk. For information on Web Start, see http://en.wikipedia.org/wiki/Java_Web_Start.

pointing to the right). Two signal plots will then be displayed in their own windows, as shown in Figure 2.1. The plot on the right shows the power spectrum and the plot on the left shows the time-domain signal. Note the four peaks, which indicate the modulated sinusoid. You can adjust the frequencies of the signal and the carrier as well as the amount

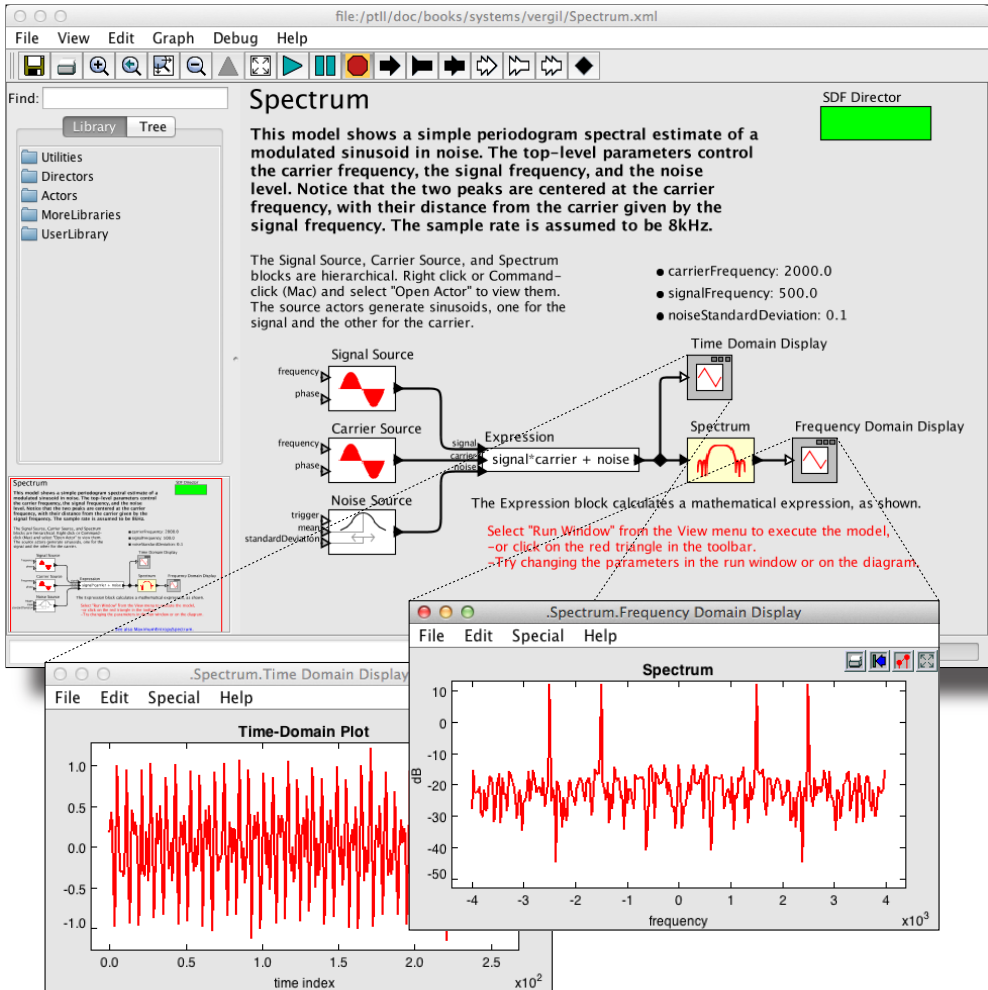

Figure 2.1: Example of a Vergil window and the windows that result from running the model. [[online](#)]

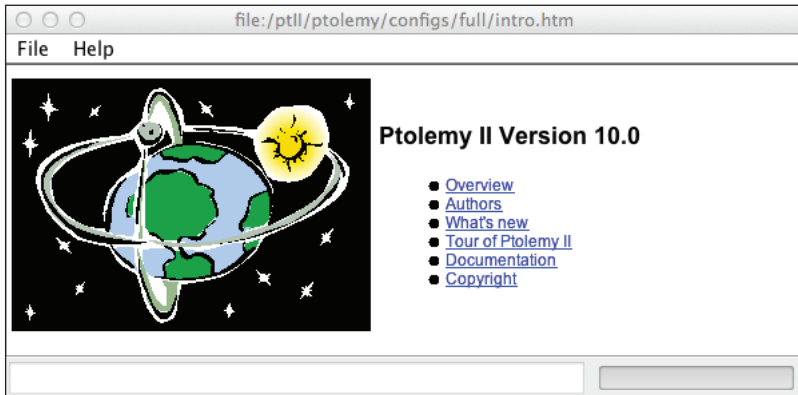

Figure 2.2: Initial welcome window.

of noise by double clicking on those parameters in the block diagram in Figure 2.1 near the upper right of the window.

The icon (the graphical block) for the [Expression](#) actor displays the expression that will be calculated:

```
signal*carrier + noise
```

The identifiers in this expression, `signal`, `carrier`, and `noise`, refer to the input ports. The Expression actor is flexible; it can have any number of input ports (which can have arbitrary names) and it uses a rich [expression language](#) to specify the value of the output as a function of the inputs. It can also specify parameters for the model in which the expression is contained. (The expression language is described in Chapter 13.)

Right clicking and selecting [`Documentation`→`Get Documentation`] displays documentation for that actor. Figure 2.4 shows the documentation for the [Expression](#) actor.

Three of the actors in Figure 2.1 are [composite actors](#), meaning that their implementation is itself a Ptolemy II model. You can invoke the `Open Actor` context menu² to reveal the

²A **context menu** is a menu that is specific to the object under the cursor. It is obtained by right clicking the mouse (or control clicking, if the mouse does not have a right button) while the cursor is over the icon.

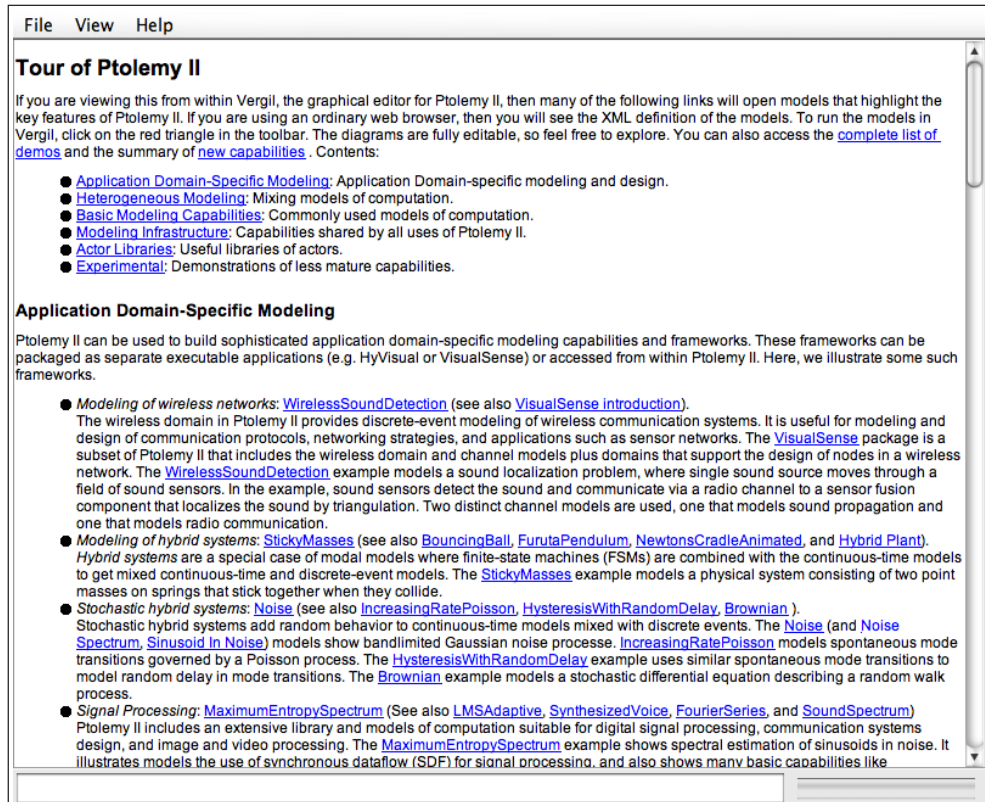

Figure 2.3: The tour of Ptolemy II page.

Signal Source implementation, as shown in Figure 2.5. This block diagram shows how the sinusoidal signal is generated.

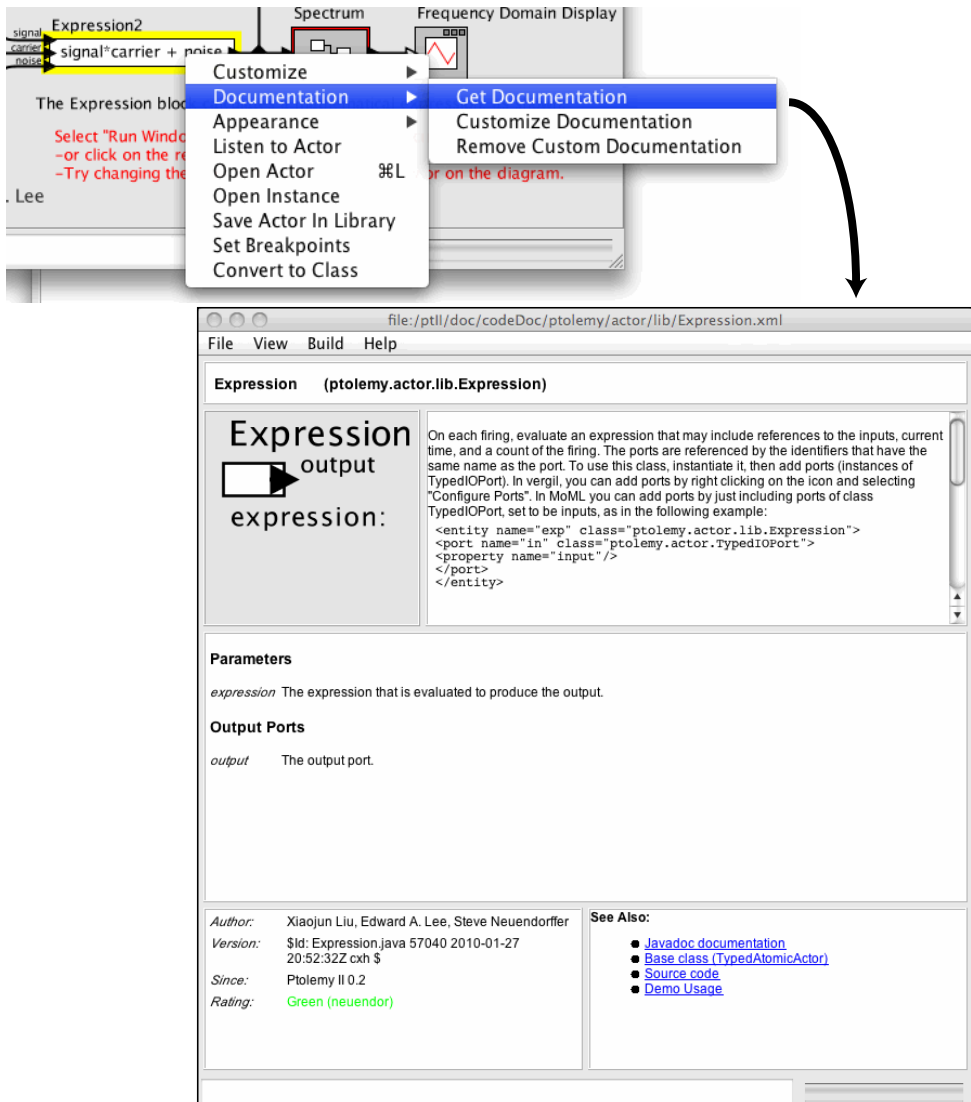

Figure 2.4: Viewing documentation for actors.

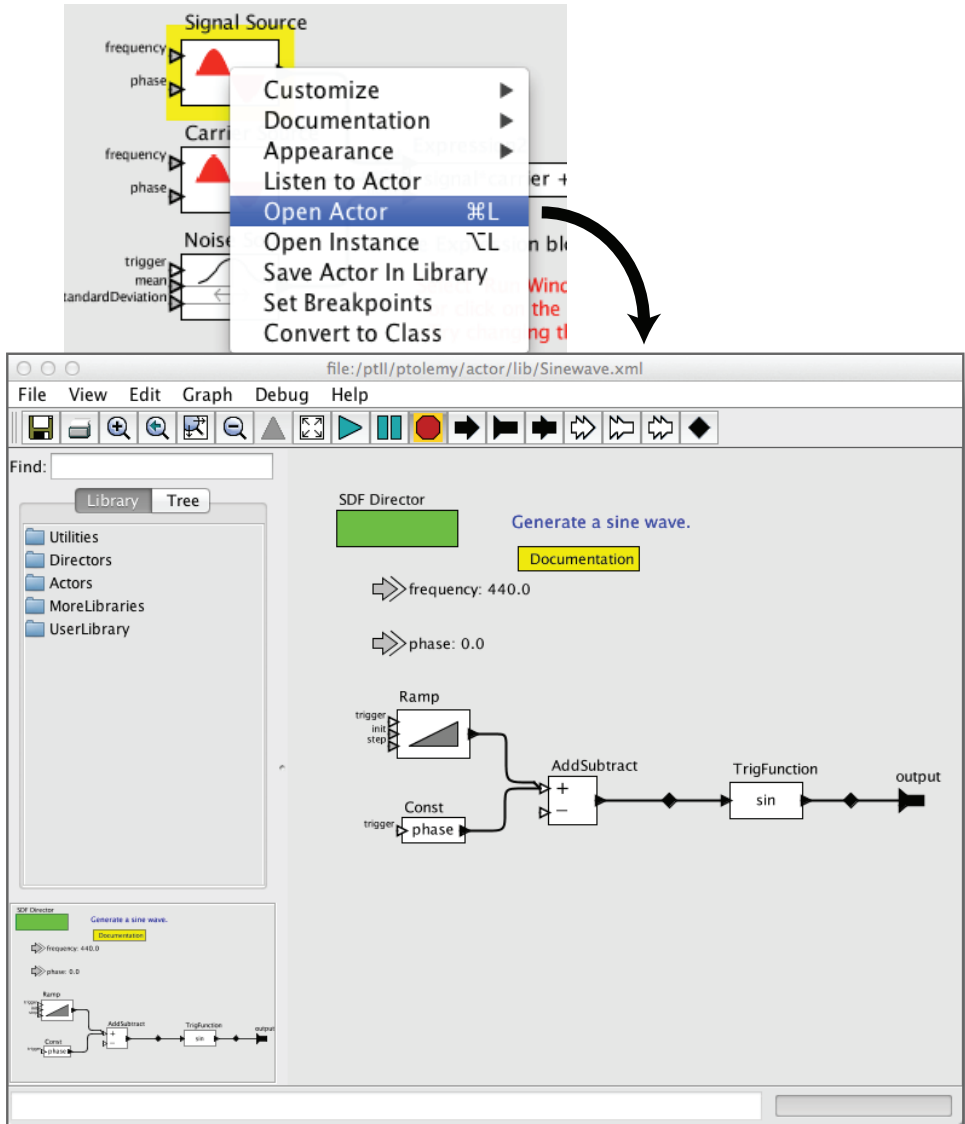

Figure 2.5: Invoke `Open Actor` on composite actors to reveal their implementation.

2.1.2 Creating and Running a Model

Create a new model by selecting [File→New→Graph Editor] in the menu bar. You should see something like the window shown in Figure 2.6. The left-hand side of the page shows a library of components that can be dragged into the model-building area. Perform the steps outlined below to create a simple model.

- Open the **Actors** library and then **Sources**. Find the **Const** actor under **Sources→Generic** and drag an instance into the model-building area.
- Open **Sinks→GenericSinks** and drag a **Display** actor onto the page (see boxes on pages 48 and 49).

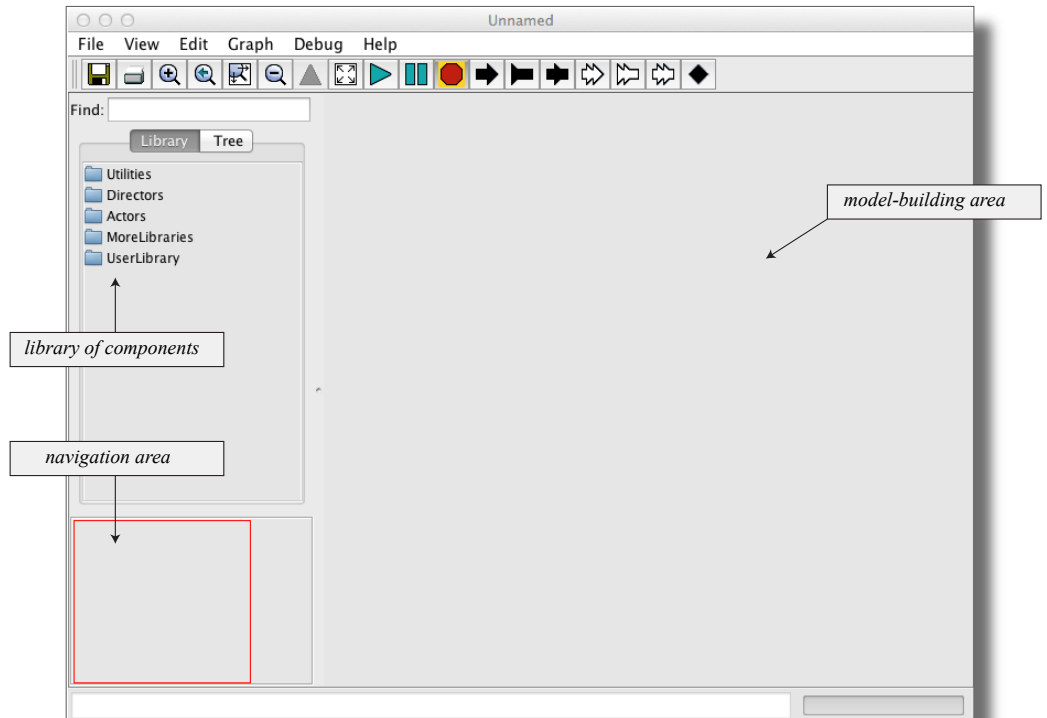

Figure 2.6: An empty Vergil Graph Editor.

- Drag a connection from the output port on the right of the Const actor to the input port of the Display actor.
- Open the `Directors` library and drag the SDF Director onto the page. The `director` controls various aspects of the model's functionality, such as (for example) how many iterations the model will execute (which is, by default, just one iteration).

Now you should have something that looks like Figure 2.7. In this model, the Const actor will create a string and the Display actor will display that string. Set the string variable to “Hello World” by double or right clicking on the Const actor icon and selecting [Customize→Configure], which will display the dialog box shown in Figure 2.8. En-

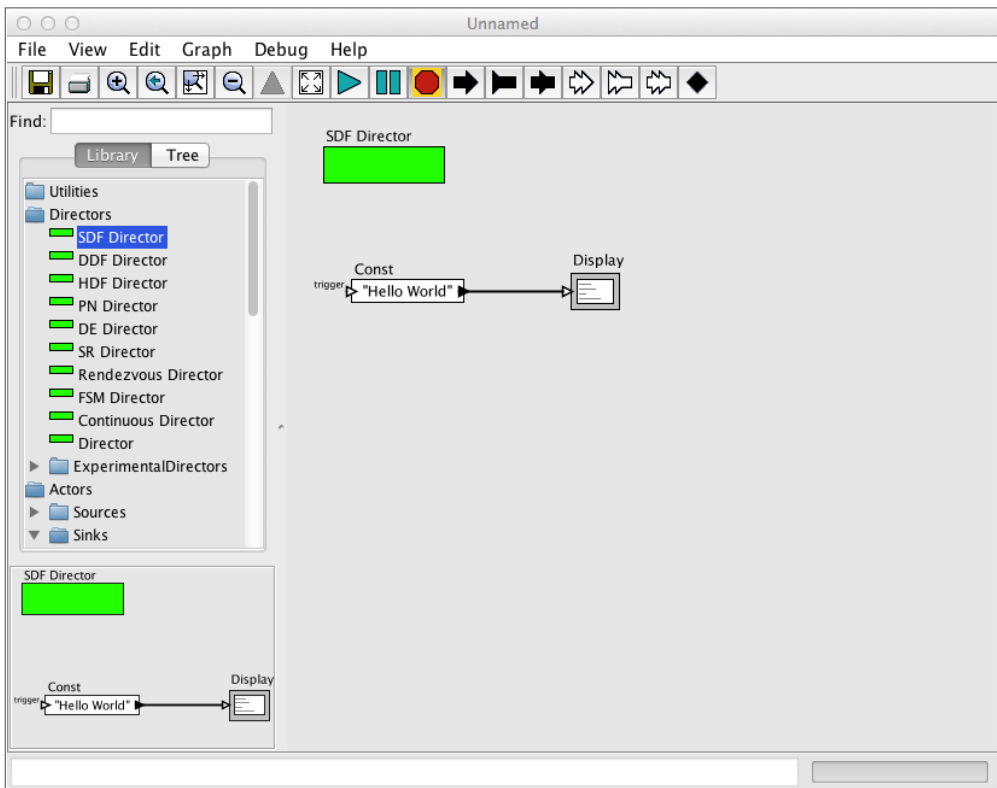

Figure 2.7: The Hello World example. [\[online\]](#)

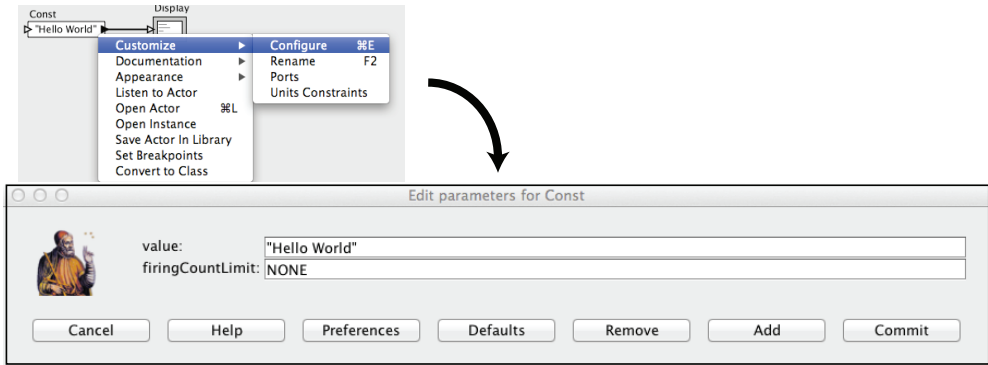

Figure 2.8: The Const parameter editor.

ter the string "Hello World" (with the quotation marks) for the *value* parameter and click the Commit button. (The quotation marks ensure that the expression will be interpreted as a string.) If you run this model, a display window will show the text “Hello World.”

You may wish to save your model using the File menu. File names for Ptolemy II models should end in “.xml” or “.moml” so that Vergil will properly process the file the next time it is opened.

2.1.3 Making Connections

The model constructed above contains two actors and one connection between them. If you move either actor (by clicking and dragging), the connection will be re-routed automatically. We can now explore how to create and manipulate more complicated connections.

First, create a model in a new graph editor that includes an SDF Director, a [Ramp](#) actor (found in the Sources→SequenceSources library), a Display actor, and a [Sequence-Plotter](#) actor (found in the Sinks→SequenceSinks library), as shown in Figure 2.9.

Suppose we wish to route the output of the Ramp actor to both the Display and the SequencePlotter. In this case, we need an explicit relation in the diagram. A **relation** is a

Sidebar: Sources Library

The three Actors→Sources libraries contain sources of signals.

Generic Sources:

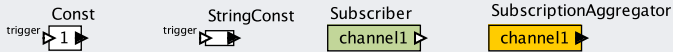

Timed Sources:

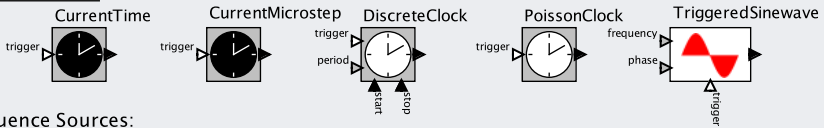

Sequence Sources:

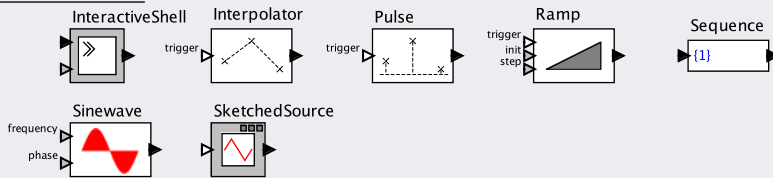

- **Const** produces a value (or expression) set by a parameter (see Chapter 13).
- **StringConst** produces strings and may reference other parameters (see Section 13.2.3).
- **Subscriber** outputs data received from a **Publisher** (described in the Sinks Library sidebar on page 49).
- **SubscriptionAggregator** combines data from multiple Publishers using a specified operation (currently addition or multiplication).
- **CurrentTime**, **CurrentMicrostep**, **DiscreteClock**, and **PoissonClock** are timed sources described in Chapter 7.
- **TriggeredSinewave** and **Sinewave** produce sinusoidal outputs based on either the current time or a specific sample rate, respectively.
- **InteractiveShell** outputs the value entered in a shell window opened during execution.
- **Interpolator** and **Pulse** both generate waveforms, one by interpolating between values, and the other by zero-filling between values.
- **Ramp** produces a steadily increasing or decreasing output sequence.
- **Sequence** produces an arbitrary sequence of values, possibly periodic.
- **SketchedSource** produces a sequence specified interactively with the mouse.

Sidebar: Sinks Library

Actors in the `Actors→Sinks` library serve as destinations for signals. Most are plotters, described in Chapter 17. The few that are not are contained in the `Sinks→GenericSinks` library, and shown below. All of these sinks accept any data type at their inputs.



- **Discard** discards all inputs. In most domains, leaving an output disconnected has the same effect (the [Rendezvous](#) domain is an exception).
- **Display** displays the values of inputs in a text window that opens when the model is executed.
- **MonitorValue** displays its inputs in the Vergil icon that displays the model.
- **Publisher** establishes named connections to instances of [Subscriber](#) and [SubscriptionAggregator](#) (described in the Sources sidebar on page 48).
- **Recorder** stores the values of inputs internally; custom Java code is then needed to access those values.
- **SetVariable** sets the value of a variable or parameter defined in the model. Since this variable may be read by another actor that has no connection to the SetVariable actor, SetVariable may introduce nondeterminism into a model. That is, the results of executing the model may depend on arbitrary scheduling decisions that determine whether SetVariable executes before actors that read the affected variable. To mitigate this risk, SetVariable has a parameter called *delayed* that by default is set to true. When it is true, the affected variable will only be set at the end of the current [iteration](#) of the director. For most directors (but notably, not for [PN](#) or [Rendezvous](#)), this setting will ensure deterministic behavior. The SetVariable actor has an output port that can be used to ensure that other specified actors are executed only after SetVariable executes. This approach can also eliminate nondeterminacy, even if *delayed* is set to false.

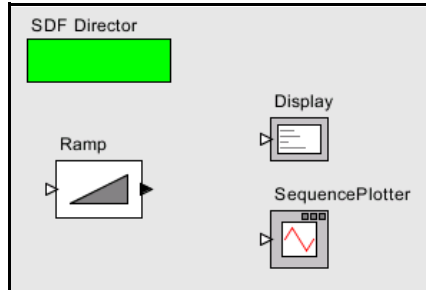

Figure 2.9: Three unconnected actors in a model.

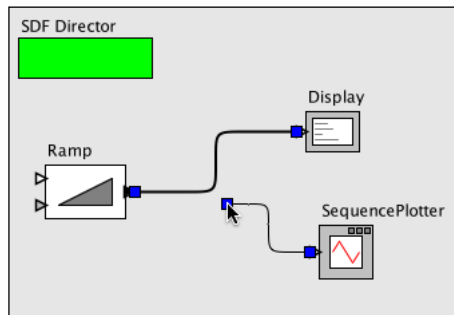

Figure 2.10: Dragging a connection to an existing one will create a three-way connection by creating an explicit relation.

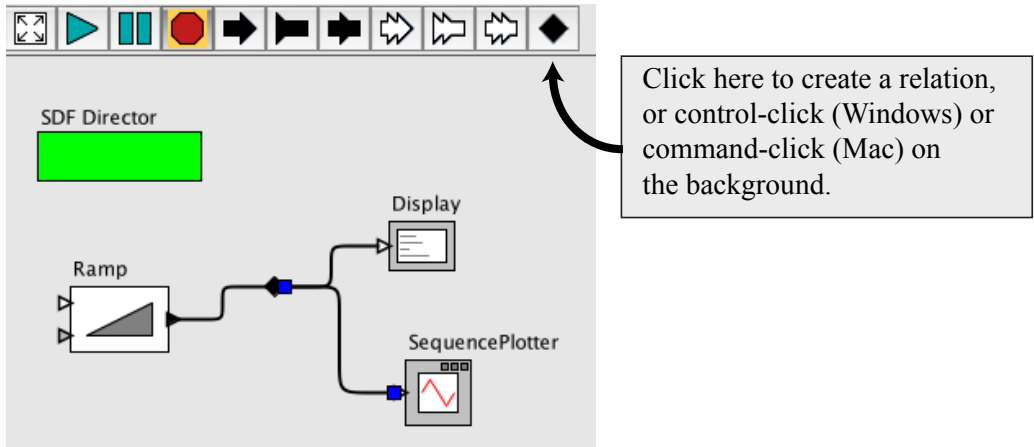

Figure 2.11: A relation can also be created by clicking on the black diamond in the toolbar.

splitter that enables connecting more than two ports; it is represented in the diagram by a black diamond, as shown in Figure 2.11. It can be created in several ways:

- Drag the endpoint of a link into the middle of an existing line, as shown in Figure 2.10.
- Control-click³ on the background. A relation will appear.
- Click on the button in the toolbar with the black diamond on it, as shown in Figure 2.11.

Note that if you simply click and drag on the relation, the relation is selected and moved, which does not result in a connection. To make a connection, hold the control key while clicking and dragging on the relation.

In the model shown in Figure 2.11, the relation is used to broadcast the output from a single port to a number of places. The single port still has only one connection — a connection to the relation.

Even with the simple diagrams we have created so far, it can become tedious to arrange the icons and control the routing of wires between ports and relations. Fortunately, Ptolemy II includes a sophisticated automated layout tool, which you can find in the [Graph→

³On a Macintosh, use command-click. (This substitution applies throughout the book.)

Automatic Layout] menu command (or invoke using Control-T). This tool was contributed by Spönemann et al. (2009). Occasionally, however, you may still need to manually adjust the layout. To specifically control the routing of connections, you can use multiple relations along a connection and independently control the position of each one. Multiple relations used in a single connection are called a **relation group**. In a relation group, there is no significance to the order in which relations are linked.

Ptolemy II supports two types of ports, which are indicated by filled and unfilled triangles. Filled triangles designate single-input (or single-output) ports, while unfilled triangles allow multiple inputs (or outputs). For example, the output port of the Ramp actor is a **single port**, while the input port of the Display and SequencePlotter actors are **multiports**. In multiports, each connection is treated as a separate **channel**.

Choose another signal source from the library and add it to the model. Connect this additional source to the SequencePlotter or to the Display, thus implementing a multiport input to those blocks. Not all data type inputs will be accepted, however; the SequencePlotter, for example, can only accept inputs of type *double* or types that can be losslessly converted to *double*, such as *int*. In the next section, we discuss data types and their use in Ptolemy II models.

2.2 Tokens and Data Types

In the example of Figure 2.7, the **Const** actor creates a sequence of values on its output port. Each value in the sequence is called a **token**. A token is created by one actor, sent through an output port, and received by one or more destination actors, each of which retrieves the token through an input port. In this case, the Display actor will receive the tokens produced by the Const actor and display them in a window. A token is simply a unit of data, such as a string or numerical value, that is communicated between two actors via ports.

The tokens produced by the Const actor can have any value that can be expressed in the Ptolemy II **expression language** (see Chapter 13). Try setting the value to 1 (the integer with value one), or 1.0 (the floating-point number with value one), or {1.0} (a single-entry array containing 1.0), or {value=1, name="one"} (a record with two elements: an integer named “value” and a string named “name”), or even [1,0;0,1] (the two-by-two identity matrix). These are all valid expressions that can be used in the Const actor.

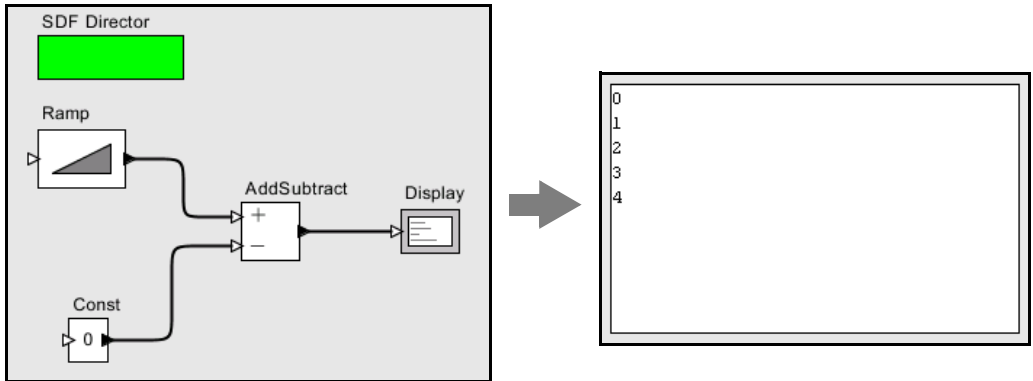

Figure 2.12: Another example, used to explore data types. [[online](#)]

The Const actor is able to produce data with different **types**, and the Display actor is able to display data with different types. Most actors in the actor library are **polymorphic actors**, meaning that they can operate on or produce data with multiple types, though their specific processing behavior may be different for different types. Multiplying matrices, for example, is not the same operation as multiplying integers, but both can be accomplished using the [MultiplyDivide](#) actor in the `Math` library. Ptolemy II includes a sophisticated [type system](#) that allows actors to process different data types efficiently and safely. The type system was created by [Xiong \(2002\)](#) and is described in Chapter 14.

To explore data types further, create the model in Figure 2.12, using the SDF Director. The [Ramp](#) actor is listed under the `Sources`→`SequenceSources` sublibrary, and the [AddSubtract](#) actor is listed under the `Math` library (see box on page 57). Set the *value* parameter of the Const to be 0 and the *iterations* parameter of the director to 5. Running the model will result in the display of five consecutive numbers starting at 0 and ending at 4, as shown in the figure. These values are produced by subtracting the constant output of the Const actor from the current value of the Ramp. Experiment with changing the value of the Const actor and see how it changes the five numbers at the output.

Now change the value of the Const actor back to "Hello World". When you execute the model, you should see an **exception** window, as shown in Figure 2.13. This error is caused by attempting to subtract a string value from an integer value. This error is one kind of **type error**.

The actor that caused the exception is highlighted, and the name of the actor is shown in the exception. In Ptolemy II models, all objects have a dotted name. The dots separate elements in the hierarchy. Thus, “.helloWorldSubtractError.AddSubtract” is an object named “AddSubtract” contained by an object named “.helloWorldAddSubtractError”. (The model was saved as a file called `helloWorldAddSubtract.xml`.)

Exceptions can be a very useful debugging tool, particularly when developing components in Java. To illustrate how to use them, click on the Display Stack Trace button in the exception window of Figure 2.13. You should see a stack trace like that shown in Figure 2.13. This window displays the execution sequence that resulted in the exception. For example, if you scroll towards the bottom, text similar to the following will be displayed:

```
at ptolemy.data.StringToken._subtract (StringToken.java:359)
```

This line indicates that the exception occurred within the `subtract` method of the class `ptolemy.data.StringToken`, at line 359 of the source file `StringToken.java`. Since Ptolemy II is distributed with source code (and most installation mechanisms support installation of the source), this can be very useful information. For type errors, you probably do not need to see the stack trace, but if you have extended the system with your own Java code or you encounter a subtle error that you do not understand, then looking at the stack trace can be very illuminating.

To find the file `StringToken.java` referred to above, find the Ptolemy II installation directory. If that directory is `$PTII`, then the location of this file is given by the full class name, but with the periods replaced by slashes; in this case, it is at

```
$PTII/ptolemy/data/StringToken.java
```

The slashes will be backslashes under Windows.

Let’s try a small change to the model to eliminate the exception. Disconnect the `Const` actor from the lower port of the `AddSubtract` actor and connect it instead to the upper port, as shown in Figure 2.14. You can do this by selecting the connection, deleting it (using the delete key), and adding a new connection—or by selecting it and dragging one of its endpoints to the new location. Notice that the upper port is an unfilled triangle; this indicates that you can make more than one connection to it. Now when you run the model you should see a sequence of string values starting with “0Hello World”, as shown in

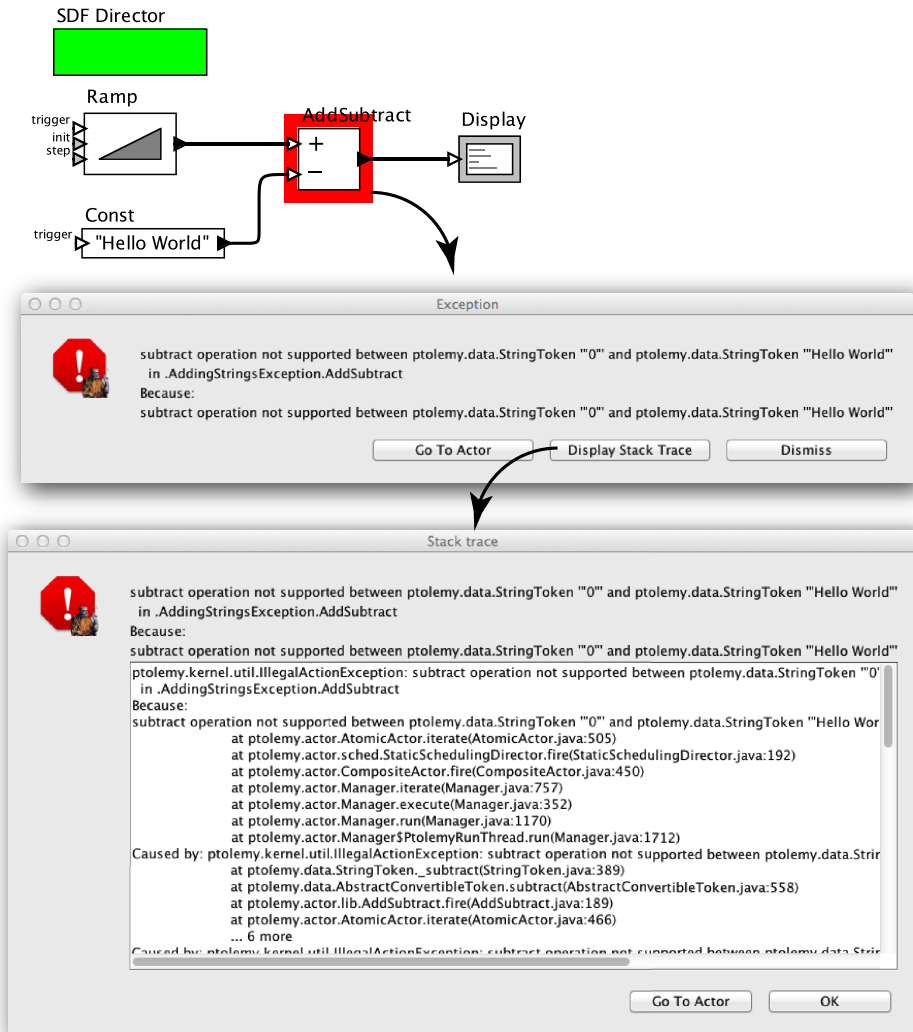

Figure 2.13: An example that triggers an exception when you attempt to execute it. Strings cannot be subtracted from integers. Examining the stack trace for such exceptions can sometimes be useful for debugging your model, particularly if it includes custom actors. [\[online\]](#)

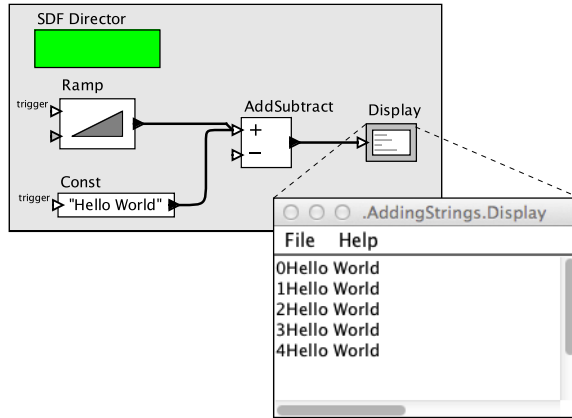

Figure 2.14: Addition of a string to an integer. [\[online\]](#)

the figure. Following Java conventions, strings can be added (using concatenation), but they cannot be subtracted.

All the connections to a multiport must have the same type. In this case, the multiport has a sequence of integers coming in (from the Ramp) and a sequence of strings (from the Const). The Ramp integers are automatically converted to strings and concatenated with “Hello World” to generate the output sequence.

As illustrated by the above example, Ptolemy II automatically performs type conversions when required by the actor, if possible. As a rough guideline, Ptolemy II will perform automatic type conversions when there is no loss of information. An *int* can be converted to a *string*, for example, but not vice versa. An *int* can be converted to a *double*, but not vice versa. An *int* can be converted to a *long*, but not vice versa. The details are explained in Chapter 14, but it is usually not necessary to remember the conversion rules. Typically, the data type conversions and resulting computations will perform as would be expected.

To further explore data types, try modifying the Ramp so that its parameters have different types. For example, try making *init* and *step* strings.

Sidebar: Math Library

Actors in the `Actors`→`Math` library perform mathematical operations, and are shown below (except the most versatile, [Expression](#), explained in Chapter 13).

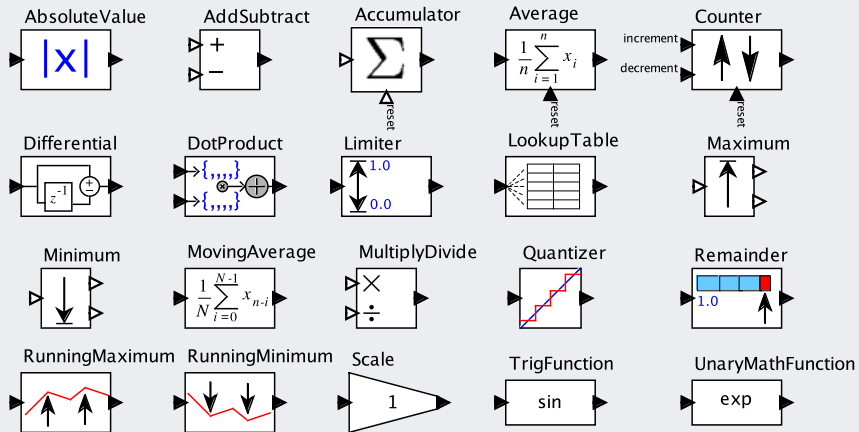

These are mostly self explanatory:

- **AbsoluteValue** computes the absolute value of the input.
- **AddSubtract** adds tokens at the *plus* inputs, and subtracts tokens at the *minus* inputs.
- **Accumulator** outputs the sum of all tokens that have arrived.
- **Average** outputs the average of all tokens that have arrived.
- **Counter** counts up or down when inputs are received on the two input ports.
- **Differential** outputs the difference between the current input and the previous one.
- **DotProduct** computes the inner product of two array or matrix inputs.
- **Limiter** limits the value of the input to a specified range of values.
- **LookupTable** performs a lookup into a table provided as an array.

(Continued on page 58.)

Sidebar: Math Library (Continued)

- **Maximum** outputs the maximum of the currently available input tokens.
- **Minimum** outputs the minimum of the currently available input tokens.
- **MovingAverage** outputs the average of some number of the most recent inputs.
- **MultiplyDivide** multiplies the tokens on the *multiply* inputs, and divides by the tokens on the *divide* inputs.
- **Quantizer** outputs the nearest value to the input from a specified list of values.
- **Remainder** outputs the remainder after dividing the input by the *divisor* parameter.
- **RunningMaximum** outputs the maximum value seen so far at the input.
- **RunningMinimum** outputs the minimum value seen so far at the input.
- **Scale** multiplies the input by a constant given as a parameter.
- **TrigFunction** performs trigonometric functions, including cosine, sine, tangent, arc-cosine, arcsine, and arctangent.
- **UnaryMathFunction** performs various math functions with a single argument, including exponentiation, logarithm, sign, squaring, and square root.

There are subtleties. Some actors with multiple input ports ([AddSubtract](#), [Counter](#), and [MultiplyDivide](#)) or with [multiport](#) inputs ([Maximum](#) and [Minimum](#)), do not require input tokens on all input channels. When these actors fire, they operate on whatever input tokens are available. For example, if [AddSubtract](#) has no tokens on any *plus* input channel, and only one token on a *minus* input channel, then the output will be the negative of that one token. Whether inputs are available when the actor fires depends on the director and the model. With the [SDF](#) director, exactly one input token is provided on every input channel for every firing.

These actors are **polymorphic**; they can operate on a variety of data types. For example, the [AbsoluteValue](#) actor accepts inputs of any scalar type (see Chapter 14). If the input type is *complex*, it computes the magnitude. For other scalar types, it computes the absolute value.

[Accumulator](#) and [Average](#) both have *reset* input ports (at the bottom of the icon). They calculate the sum or average of sequences of inputs, and they can be reset.

2.3 Hierarchy and Composite Actors

Ptolemy II supports (and encourages) hierarchical models. These are models that contain components that are themselves models. These components are called **composite actors**.

Consider the typical signal processing problem of recovering a signal from a noisy channel. Using Ptolemy II, we will create a composite actor modeling a communication channel that adds noise, and then use that actor within a larger model.

To create the composite actor, drag a **CompositeActor** from the `Utilities` library. In the context menu (obtained by right clicking over the composite actor), select [`Customize` → `Rename`], and give the composite an appropriate name, like **Channel**, as shown in Figure 2.15. (Note that you can also supply a *Display name*, which is arbitrary text that will be displayed instead of the name of the actor.) Then, using the context menu again, select

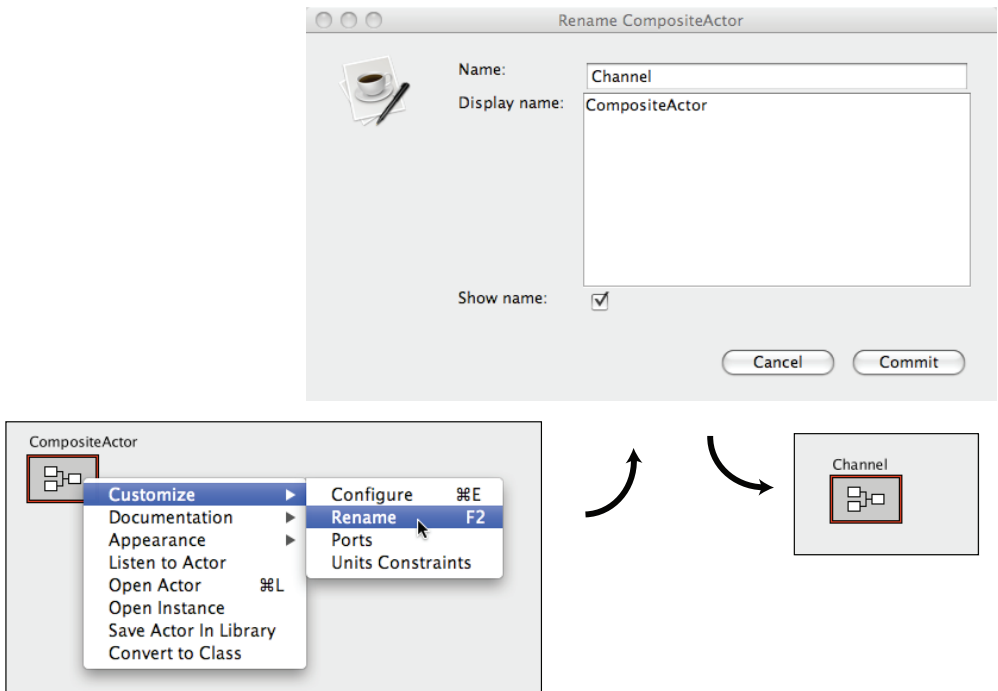

Figure 2.15: Changing the name of an actor.

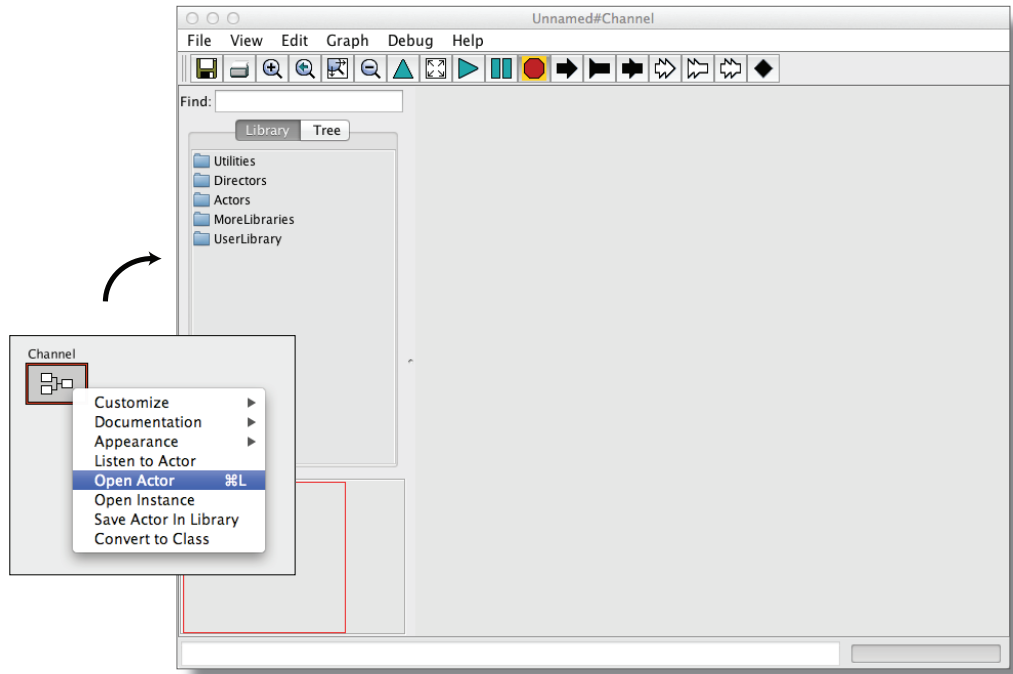

Figure 2.16: Opening a new composite actor, which shows the blank inner actor.

Open Actor. This will open a new window with an empty graph editor, as shown in Figure 2.16. Note that the original graph editor is still open; to see it, move the new graph editor window aside by dragging the title bar of the window. Alternatively, you can click on the upward pointing triangle in the toolbar to navigate back to the container.

2.3.1 Adding Ports to a Composite Actor

The newly created composite actor needs input and output ports. There are several ways to add them, the easiest of which is to click on the port buttons in the toolbar. The port buttons are shown as white and black arrowheads on the toolbar, as described in Figure 2.17. You can explore the ports in the toolbar by hovering the mouse over each button; a tool tip will pop up that describes the button.

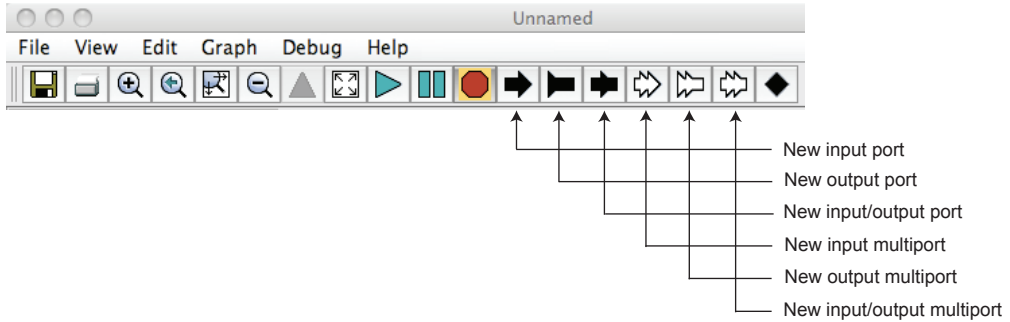

Figure 2.17: Summary of toolbar buttons for creating new ports.

Create an input port and an output port and rename them *input* and *output* by right clicking on the ports and selecting [Customize→Rename]. Note that, as shown in Figure 2.18, you can also right click on the background of the composite actor and select [Customize→Ports] to add ports, remove ports, or change whether a port is an input, an output, or a multiport. The resulting dialog box also allows you to set the type of the port, though you will typically not need to set the port type since Ptolemy II determines the type from the

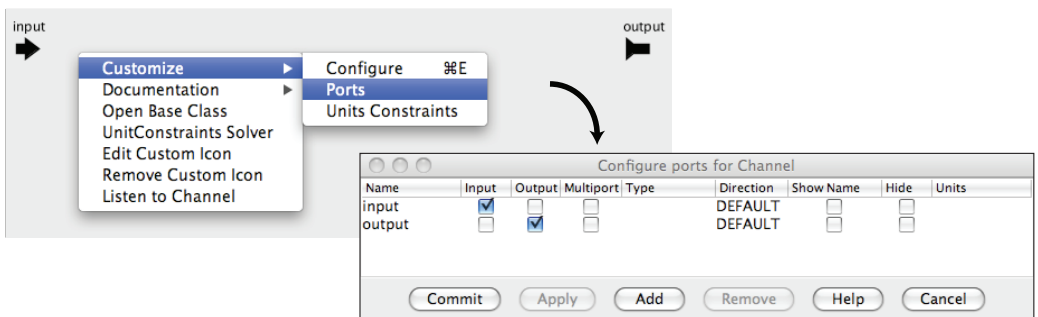

Figure 2.18: Right clicking on the background brings up a dialog that can be used to configure ports.

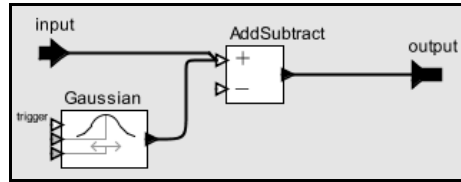

Figure 2.19: A simple channel model defined as a composite actor.

port's connections. You can also specify the direction of a port⁴ and whether the name of the port is shown outside the icon (by default it is not), or even whether the port is shown at all.

Using these ports, create the diagram shown in Figure 2.19⁵. The **Gaussian** actor, which is in the `Random` library, creates values from a Gaussian distributed random variable. If you then navigate back to the container, you should be able to easily create the model shown in Figure 2.20. The **Sinewave** actor is listed under `Sources`→`SequenceSources`, and the **SequencePlotter** actor under `Sinks`→`SequenceSinks`. The **Sinewave** actor is also a **composite actor** (try opening the actor). If you execute this model (you will probably want to set the *iterations* parameter of the director to something reasonable, like 100), you should see a plot similar to the one in Figure 2.20.

2.3.2 Setting the Types of Ports

In the above example, it was not necessary to define the port types. Their types were inferred from the connections and constants in the model, as explained in Chapter 14. Occasionally, however, you will need to set the types of the ports. Notice in Figure 2.18 that there is a column in the dialog box that enables the port type to be specified. To specify that a port has type `boolean`, for example, you could enter *boolean*. This will only have an effect, however, if the port is contained by an **opaque** composite actor (one that has its own director). In the model you have built, the **Channel** composite actor is **transparent**, and setting the types of its ports will have no effect. Transparent composite

⁴The direction of a port is defined by where it appears on the icon for the actor. By default, input ports appear on the left, output ports on the right, and ports that are both inputs and outputs appear on the bottom of the icon.

⁵Hint: to create a connection starting on one of the external ports, hold down the control key when dragging, or on a Macintosh, the command key.

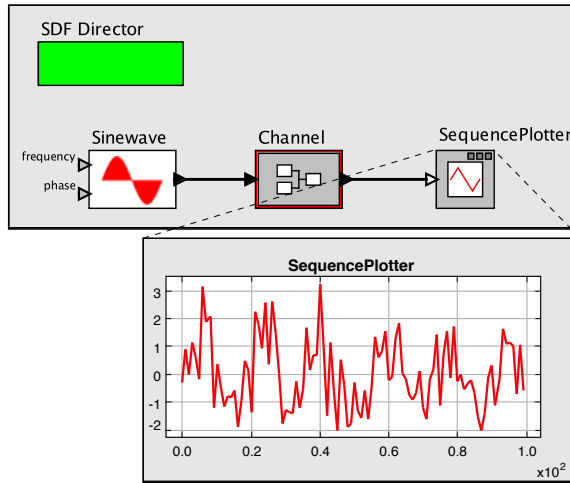

Figure 2.20: A simple signal processing example that adds noise to a sinusoidal signal. [\[online\]](#)

actors are merely a notational convenience, and the ports of the composite play no role in the execution of the model.

Commonly used types include *complex*, *double*, *fixedpoint*, *float*, *general*, *int*, *long*, *matrix*, *object*, *scalar*, *short*, *string*, *unknown*, *unsignedByte*, *xmlToken*, *arrayType(int)*, *arrayType(int, 5)*, *[double]* and *{x=double, y=double}*. A detailed description of types appears in Chapter 14.

In the Ptolemy II expression language, square braces are used for matrices, and curly braces are used for arrays. An [array](#) is an ordered list of tokens of arbitrary type. A Ptolemy II [matrix](#) is a one- or two-dimensional structure containing numeric types. To specify a double matrix port type, for example, you would use the following expression:

```
[double]
```

This expression creates a 1 x 1 matrix containing a *double* (the value of which is irrelevant here). It serves as a prototype to specify a double matrix type. Similarly, we can specify an array of complex numbers as

```
{complex}
```

A **record** has an arbitrary number of data elements, each of which has a name and a value, where the value can be of any type. To specify a record containing a string called “name” and an integer called “address” you would use the following expression to specify the type:

```
{name=string, address=int}
```

Details about arrays, matrices, and records are given in Chapter 13.

2.3.3 Multiports, Busses, and Hierarchy

As explained above in Section 2.1.3, a **multiport** handles multiple independent channels. In a similar manner, a **relation** can handle multiple independent channels. A relation has a *width* parameter, which by default is set to Auto, meaning that the width is inferred from the context. If the width is not unity, it will be displayed as shown in Figure 2.21

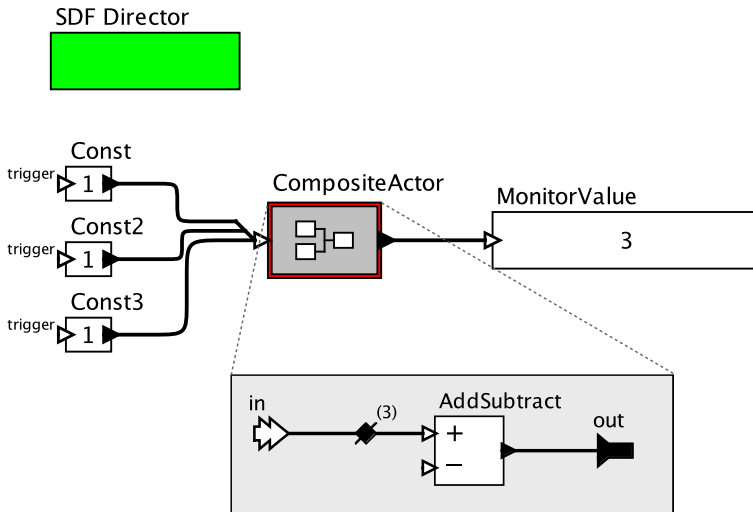

Figure 2.21: Relations can have a width greater than one, meaning that they carry more than one channel. The width of the relation inside the composite in this figure is inferred to be three. [[online](#)]

as a number adjacent to a slash through a relation. Such a connection is called a **bus**, because it carries multiple signals. If in the example in Figure 2.21 you set the width of the relation inside the composite to 2, then only two of the three channels will be used inside the composite.

In most circumstances, the width of a relation is inferred from the usage (Rodiers and Lickly, 2010), but occasionally it is useful to set it explicitly. You can also explicitly construct a bus using the **BusAssembler** actor, or split one apart using a **BusDisassembler** actor, both found in the `FlowControl→Aggregators` library.

2.4 Annotations and Parameterization

In this section, we will enhance the model in Figure 2.20 in several ways. We will add parameters, insert decorative and documentary annotations, and customize the actor icons.

2.4.1 Parameters in Hierarchical Models

First, notice from Figure 2.20 that the noise overwhelms the sinusoid, making it barely visible. A useful modification to this channel model would be to add a **parameter** that sets the level of the noise. To make this change, open the channel model by right clicking on it and selecting `Open Actor`. In the channel model, add a parameter by dragging one in from the sublibrary `Utilities→Parameters`, as shown in Figure 2.22. Right click on the parameter to rename it to `noisePower`. (To use a parameter in expressions, its name cannot have spaces.) Right click (or double click) on the parameter to change its default value to 0.1.

This parameter can now be used to set the amount of noise. The **Gaussian** actor has a parameter called *standardDeviation*. Since the noise power is equal to the variance, not the standard deviation, change the *standardDeviation* parameter so that its value is `sqrt(noisePower)`, as shown in Figure 2.23. (See Chapter 13 for details on the expression language.)

To observe the effect of the parameter, return to the top-level model and edit the parameters of the Channel actor (by either double clicking or right clicking and selecting [`Customize→Configure`]). Change the *noisePower* from the default 0.1 to 0.01. Run the model. You should now get a relatively clean sinusoid like that shown in Figure 2.24.

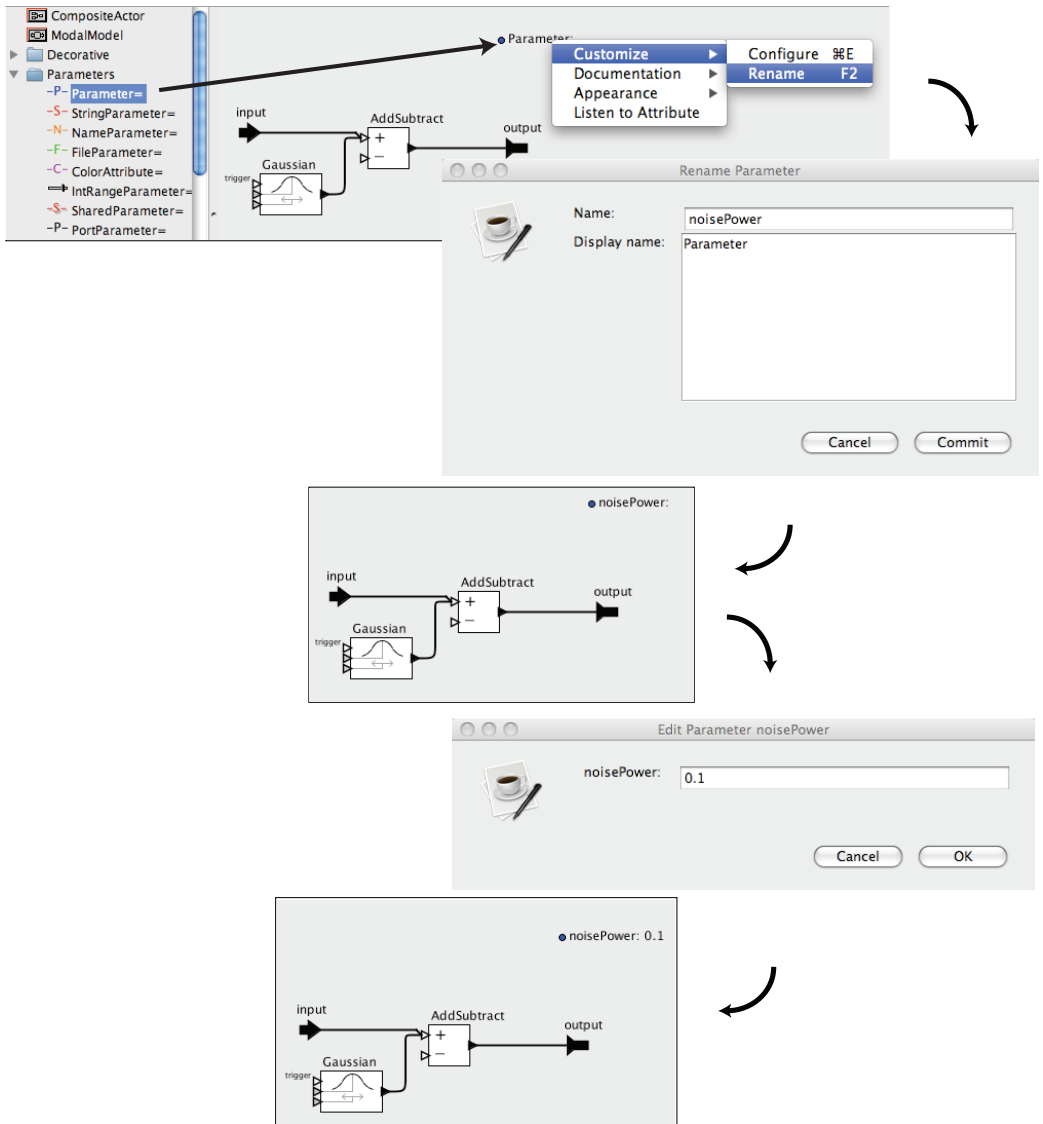

Figure 2.22: Adding a parameter to the Channel model. [online]

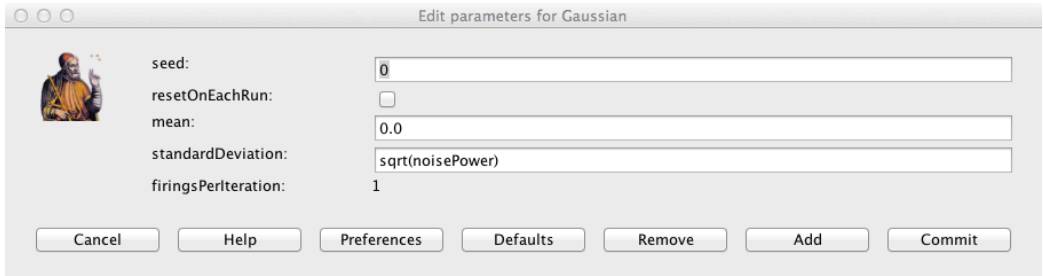

Figure 2.23: The standard deviation of the Gaussian actor is set to the square root of the noise power.

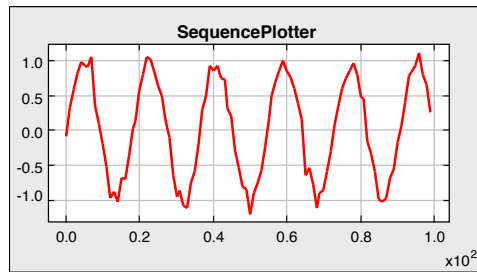

Figure 2.24: The output of the simple signal processing model in Figure 2.20 with noise power = 0.01. [\[online\]](#)

You can also add parameters to a composite actor by clicking on the “Add” button in the edit parameters dialog for the Channel composite. This dialog is accessed by double clicking on the Channel icon, by right clicking and selecting [Customize→Configure], or by right clicking on the background inside the composite and selecting [Customize→Configure]. A key point to note here is that parameters that are added this way will not be visible in the diagram, so this mechanism should be used sparingly and only when there is a good reason to hide parameters from someone browsing the model.

Finally, note that it is possible to create an object called a **port parameter** or **parameter port** that is both a parameter and a port. The *frequency* and *phase* objects in Figure 2.5 are port parameters. They can be accessed in an expression like any other parameter, but when an input arrives at the parameter port during execution, the value of the parameter

gets updated. To create a port parameter object in a model, simply drag one in from the `Utilities→Parameters` library and assign it a name.

2.4.2 Decorative Elements

The model can also be enhanced with a variety of decorative elements — that is, elements that affect its appearance but not its functionality. Such elements can improve the readability and aesthetics of a model. For example, try dragging an *Annotation* from the `Utilities→Decorative` sublibrary, and creating a title for the diagram. Such annotations are highly recommended; they correspond to comments in programs and can greatly improve readability. Other decorative elements (such as geometric shapes) can be dragged into the diagram from the same library.

2.4.3 Creating Custom Icons

Vergil provides an icon editor to enable users to create custom actor icons. To create a custom icon, right click on the standard icon and select [`Appearance→Edit Custom Icon`], as shown in Figure 2.25. The box in the middle of the icon editor displays the size of the default icon, for reference. Try creating an icon like the one shown in Figure 2.26. Hint: The fill color of the rectangle is set to `none` and the fill color of the trapezoid is first set using the color selector, then modified to have an *alpha* (transparency) of 0.5. Finally, since the icon itself has the actor name in it, the [`Customize→Rename`] dialog is used to deselect *show name*.

2.5 Navigating Larger Models

Some models are too large to view on one screen. There are four toolbar buttons, shown in Figure 2.27, that permit zooming in and out. The “Zoom reset” button restores the zoom factor to its original value, and “Zoom fit” calculates the zoom factor so that the entire model is visible in the editor window.

It is also possible to pan over a model. Consider the window shown in Figure 2.28. Here, we have zoomed in so that icons are larger than the default. The **pan window** at the lower left shows the entire model, with a red box indicating the visible portion of the model. By clicking and dragging in the pan window, it is easy to navigate the entire model.

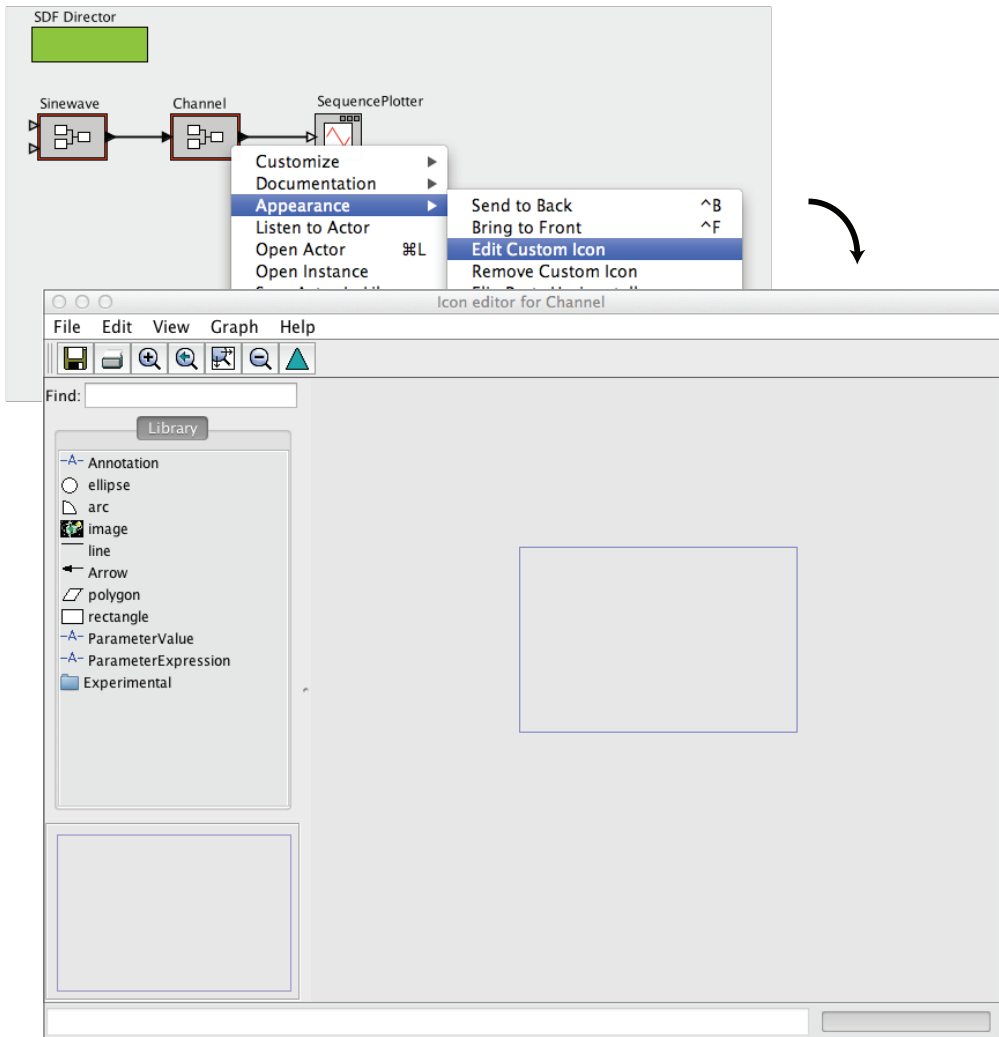

Figure 2.25: Custom icon editor for the Channel actor.

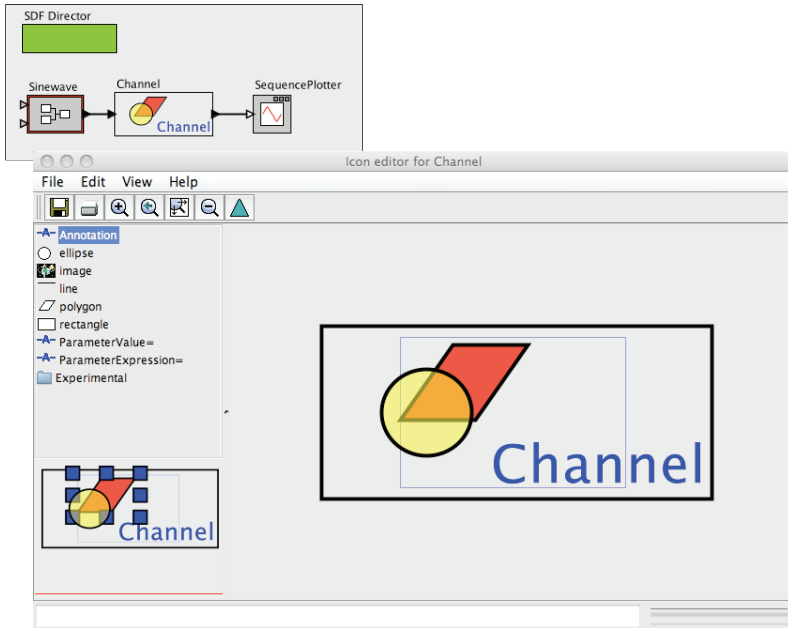

Figure 2.26: Custom icon for the Channel actor. [[online](#)]

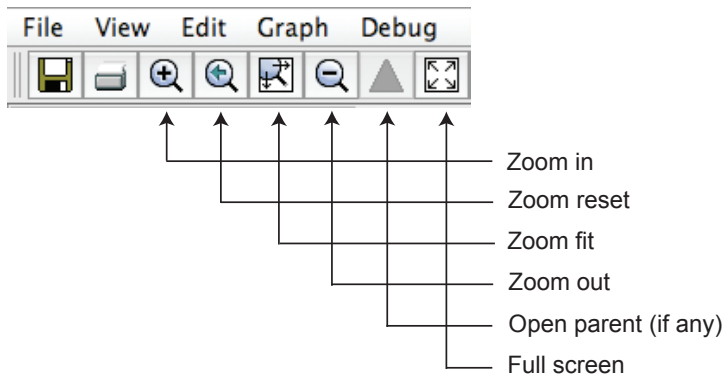

Figure 2.27: Summary of toolbar buttons for zooming and fitting.

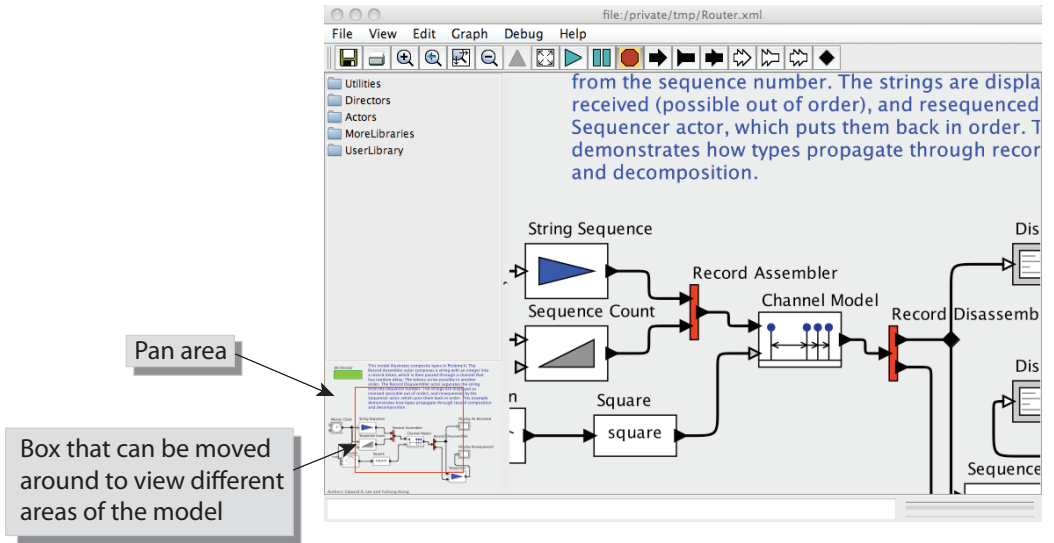

Figure 2.28: The pan window at the lower left has a red box representing the visible area of the model in the main editor window. This red box can be moved around to view different parts of the model.

2.6 Classes and Inheritance

Ptolemy II includes the ability to define **actor-oriented classes** (Lee et al., 2009a). These classes can then be used to create **instances** and **subclasses**, both of which use the concept of class **inheritance**. A class provides a general definition (or template) for an actor. An instance is a single, specific occurrence of that class, and a subclass is derived from the class — it includes the same structure, but may have some modifications. This approach improves design modularity, as illustrated in the example below.

Example 2.1: Consider the model that was developed in Section 2.3, shown for reference in Figure 2.29. Suppose that we wish to create multiple instances of the channel, as shown in Figure 2.30. In that figure, the sinewave signal passes through five distinct channels (note the use of a black-diamond relation between the sine wave and the channels to broadcast the same signal to each of the five

channels). The outputs of the channels are added together and plotted. The result is a significantly cleaner sine wave than the one that results from one channel alone. (In communication systems, this technique is known as a diversity system, where multiple copies of a channel, each with independent noise, are used to achieve more reliable communications.)

Although it is functional, this is a poor design, for two reasons. First, the number of channels is hardwired into the diagram. (We will address that problem in the next section.) Second, each of the channels is a *copy* of the composite actor in Figure 2.29. Therefore, if the channel design needs to be changed, all five copies must be changed. This approach results in models that are difficult to maintain or scale.

A more subtle advantage to using classes and instances is that the XML file representation of the model will be smaller, since the design of the class is given only once rather than multiple times.

A better solution would be to define a Channel class, and use instances of that class to implement the diversity system. To implement this change, begin with the design in Figure 2.29, and remove the connections to the channel, as shown in Figure 2.31. Then right click and select `Convert to Class`. (Note that if you fail to first remove the connections, you will get an error message when you try to

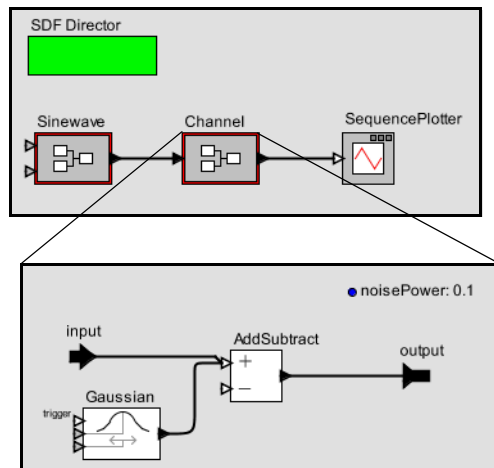

Figure 2.29: Hierarchical model that we will modify to use classes.

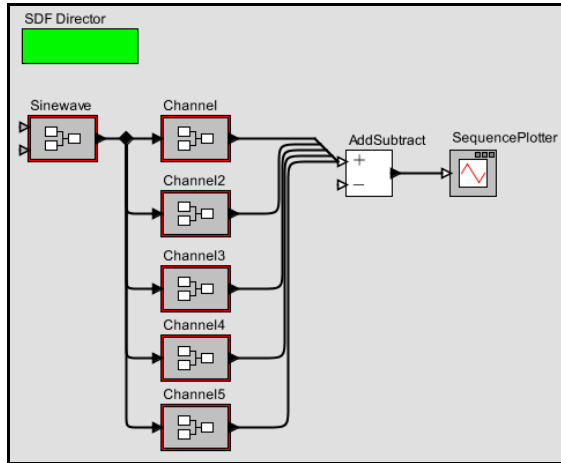

Figure 2.30: A poor design of a diversity communication system, which has multiple copies of the channel as defined in Figure 2.29. [online]

convert to class, as a class is not permitted to have connections.) The actor icon acquires a blue halo, which serves as a visual indication that it is a class rather than an ordinary actor (which is an instance).

Classes play no role in the execution of the model, and merely serve as definitions of components that must then be instantiated. By convention, we put classes at the top of the model, near the director, since they function as declarations.

Note also that instead of using `Convert to Class`, you can drag in an instance of **CompositeClassDefinition** from the `Utilities` library, and then select `Open Actor` and populate the class definition. You will want to give this class definition a more meaningful name, such as `Channel`.

Once you have defined a class, you can create an instance by right clicking and selecting `Create instance` or typing `Control-N`. Do this five times to create five instances of the class, as shown in Figure 2.31. Although this looks similar to the design in Figure 2.30, it is, in fact, a much better design, for the reasons described earlier. Try making a change to

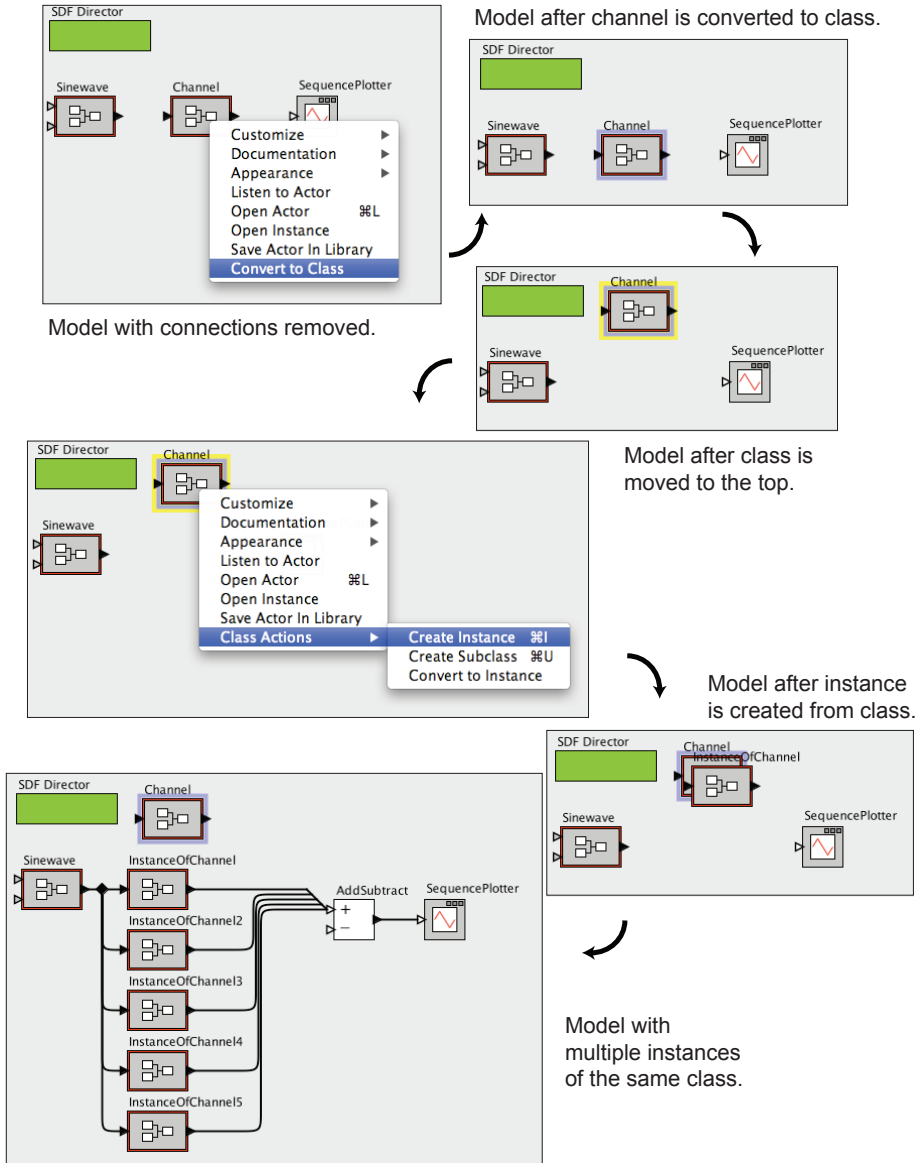

Figure 2.31: Creating and using a Channel class. [\[online\]](#)

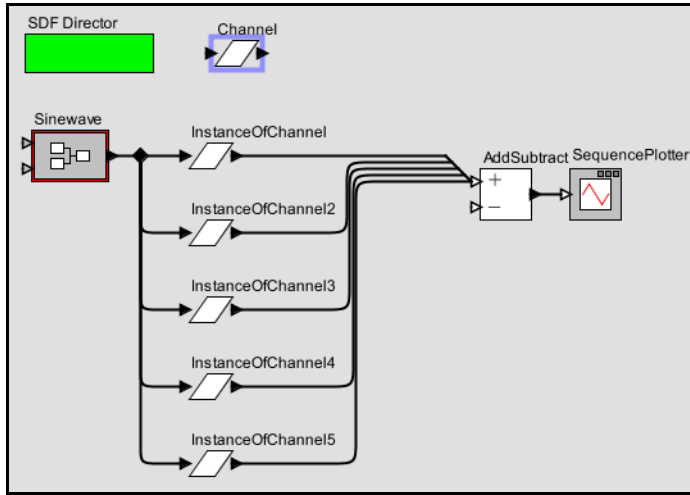

Figure 2.32: The model from Figure 2.31 with the icon changed for the class. Changes to the base class propagate to the instances. [\[online\]](#)

the class — for example, by creating a custom icon for it, as shown in Figure 2.32. Note that the changes propagate to each of the instances of the class.

If you invoke `Open Actor` on any of the instances (or the class) in Figure 2.32, you will see the same channel model. In fact, you will see the class definition. Any change you make inside this hierarchical model will be automatically propagated to all the instances. Try changing the value of the `noisePower` parameter, for example, and observe the result.

If you wish to view the instance rather than the class definition, you can select `Open Instance` on one of the instances. The window that opens shows only that instance. Each subcomponent that is inherited from the class definition is highlighted with a pink halo.

2.6.1 Overriding Parameter Values in Instances

By default, all instances of `Channel` in Figure 2.32 have the same icon and the same parameter values. However, each instance can be customized by overriding these values. In Figure 2.33, for example, we have modified the custom icons so that each has a different

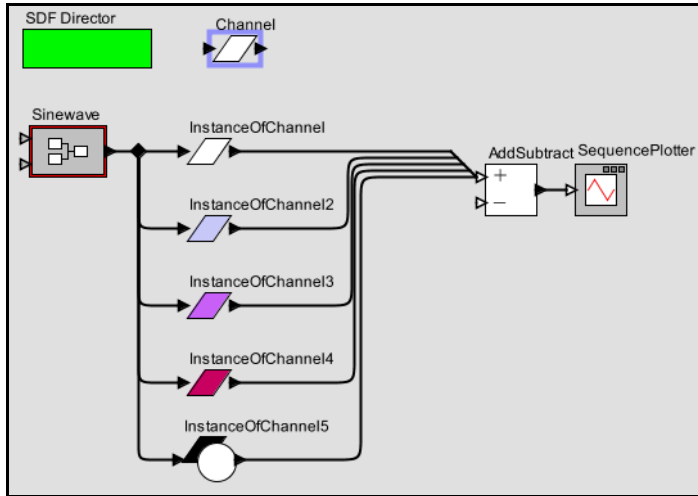

Figure 2.33: The model from Figure 2.32 with the icons of the instances changed to override parameter values in the class. [online]

color, and the fifth one has an extra graphical element. These changes are made by right clicking on the icon of the instance and selecting `Edit Custom Icon`. If you update class parameters that are overridden in an instance, then an update to the class will have no effect on the instance. It only has an effect on instances that have not been overridden.

2.6.2 Subclasses and Inheritance

Suppose now that we wish to modify some of the channels to add interference, in the form of another sine wave. A good way to do this is to create a subclass of the `Channel` class, as shown in Figure 2.34. A subclass is created by right clicking on the class icon and selecting `Create Subclass`. The resulting icon for the subclass appears on top of the icon for the class, and can be moved aside.

The subclass contains all of the elements of the class, but with the icons now surrounded by a pink halo. These elements are inherited and cannot be removed from the subclass (attempting to do so will generate an error message). You can, however, change their parameter values and add additional elements. Consider the design shown in Figure 2.35,

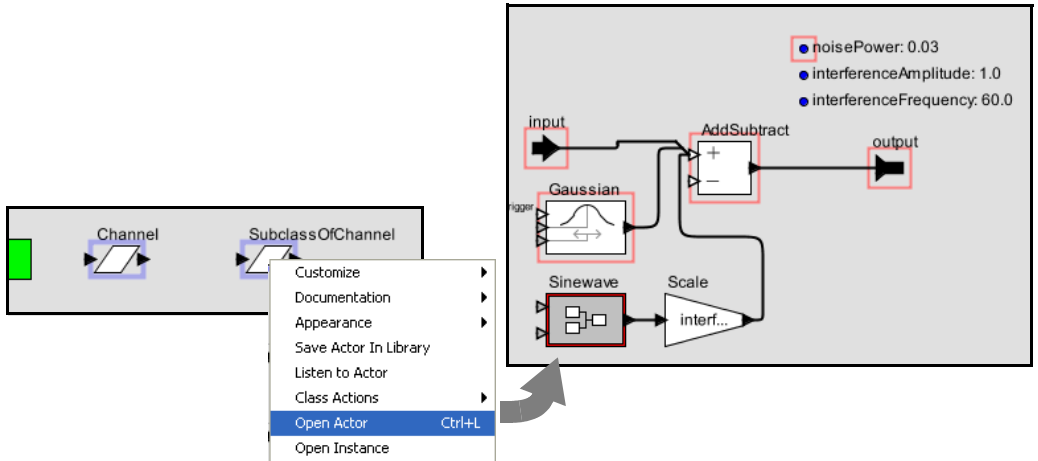

Figure 2.35: The subclass from Figure 2.34 with overrides that add sinusoidal interference. [online]

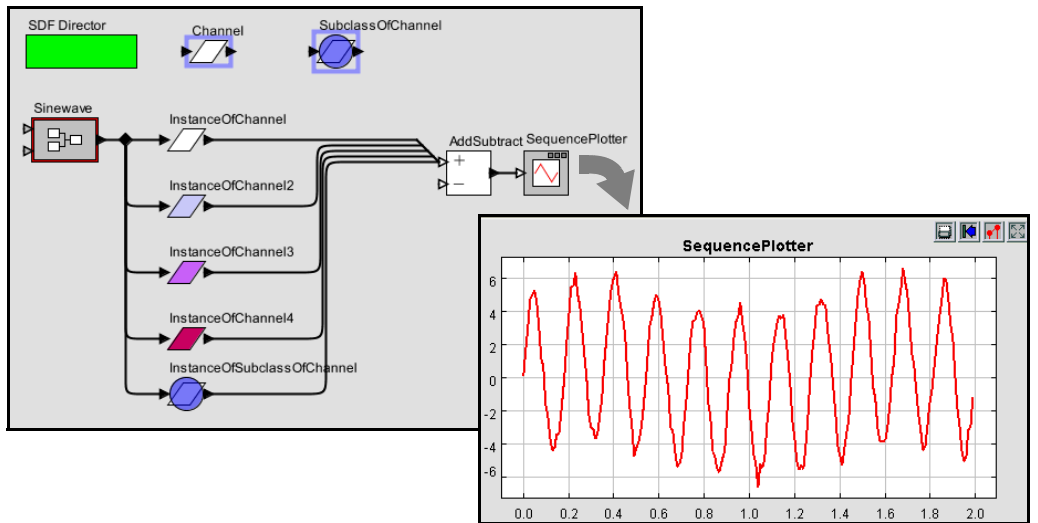

Figure 2.36: A model using the subclass from Figure 2.35 and a plot of an execution. [online]

by default unchecked. If left unchecked, the entire model will be saved.⁶ In our case, we wish to save the Channel submodel only, so we must check the box.

It is important to save the class definition in a location that will be found by the model. In general, Ptolemy II searches for class definitions relative to the **classpath**, which is given by an environment variable called CLASSPATH. In principle, you can set this environment variable to include any directory that you would like to have searched. In practice, however, changing the CLASSPATH variable may cause problems with other programs, so we recommend that you store the file in a directory within the Ptolemy II installation directory or within a directory called “.ptolemyII” in your home directory.⁷ In either case, Ptolemy will find class files stored in those directories.

Let’s assume you save the Channel class to a file called `Channel.xml` in the directory `$PTII/myActors`, where `$PTII` is the location of the Ptolemy II installation. This class definition can now be used in any model, as follows. Open the model and select `Instantiate Entity` in the `Graph` menu, as shown in Figure 2.38. Enter the fully qualified class name relative to the `$PTII` entry in the classpath, which in this case is “`myActors.Channel`”.

Once you have an instance of the Channel class that is defined in its own file, you can add it to the **UserLibrary** that appears in the library browser on the left side of Vergil windows, as shown in Figure 2.39. Right click on the instance and select `Save Actor in Library`. As shown in the figure, this causes another window to open and display the user library. The user library is itself a Ptolemy II model stored in an XML file. When you save the library model the class instance becomes available in the UserLibrary for any Vergil window (for the same user). Note that saving the class definition itself (vs. an instance of the class) in the user library does not have the same result. In that case, the user library would provide a new class definition rather than an instance of the class.

2.7 Higher-Order Components

Ptolemy II includes a number of **higher-order components**. These are actors that operate on the structure of the model rather than on input data. Consider the several examples

⁶On some platforms, a separate dialog will appear with the `Save submodel only` check box.

⁷If you don’t know where Ptolemy II is installed on your system, you can invoke `[File→New→Expression Evaluator]` and type `PTII` followed by `Enter`. Or, in a `Graph` editor, select `[View→JVM Properties]` and look for the `ptolemy.ptII.dir` property.

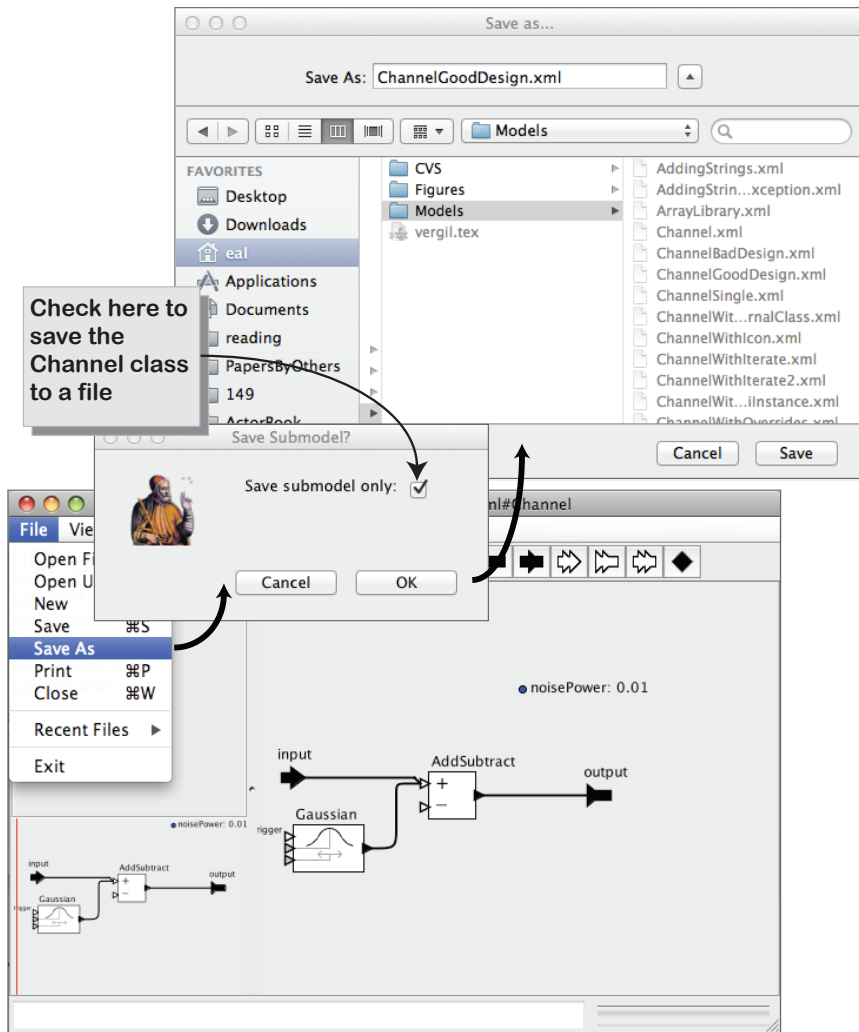

Figure 2.37: A class can be saved in a separate file to then be shared among multiple models. On some platforms, a separate dialog will appear with the `Save submodel only` check box, as shown. On others, the check box will be integrated into a single dialog. [\[online\]](#)

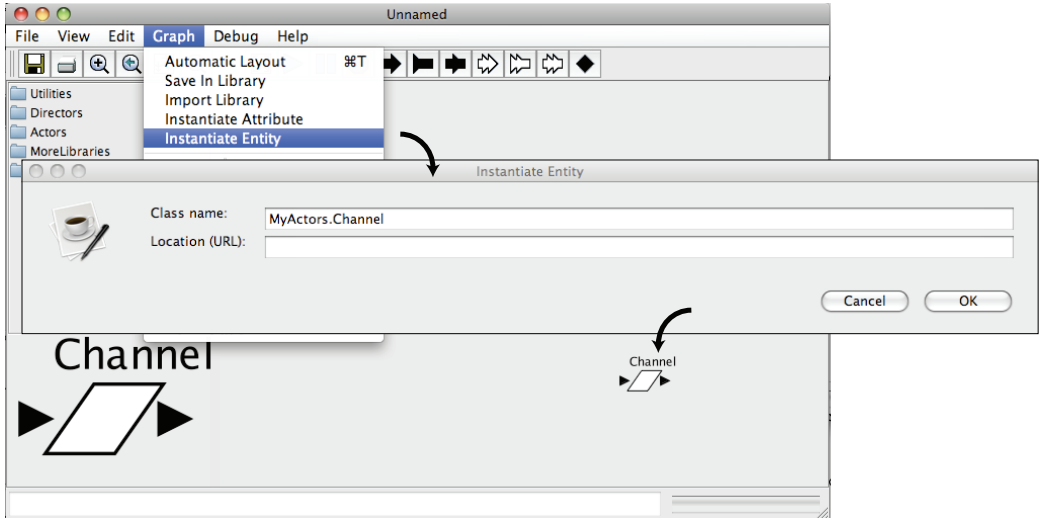

Figure 2.38: An instance of a class defined in a file can be created using `Instantiate Entity` in the `Graph` menu. [\[online\]](#)

above where five instances of the `Channel` actor are put into a model. Why five? Perhaps it would be better to have a single component that represents n instances of `Channel`, where n is a variable. This is exactly the sort of capability provided by higher-order actors. Higher-order actors, which were introduced by Lee and Parks (1995), make it easier to build large designs when the model structure does not depend on the scale of the problem. In this section, we describe a few of these actors, all of which are found in the `HigherOrderActors` library.

2.7.1 MultiInstance Composite

Consider the earlier model shown in Figure 2.32, which has five instances of the `Channel` class connected in parallel. The number of instances is hardwired into the diagram, and it is awkward to change this number, particularly if it needs to be increased. This problem can be solved by using the **MultiInstanceComposite** actor,⁸ as shown in Figure 2.40. The `MultiInstanceComposite` is a composite actor into which we have inserted a single

⁸Contributed by Zoltan Kemenczy and Sean Simmons, of Research In Motion Limited.

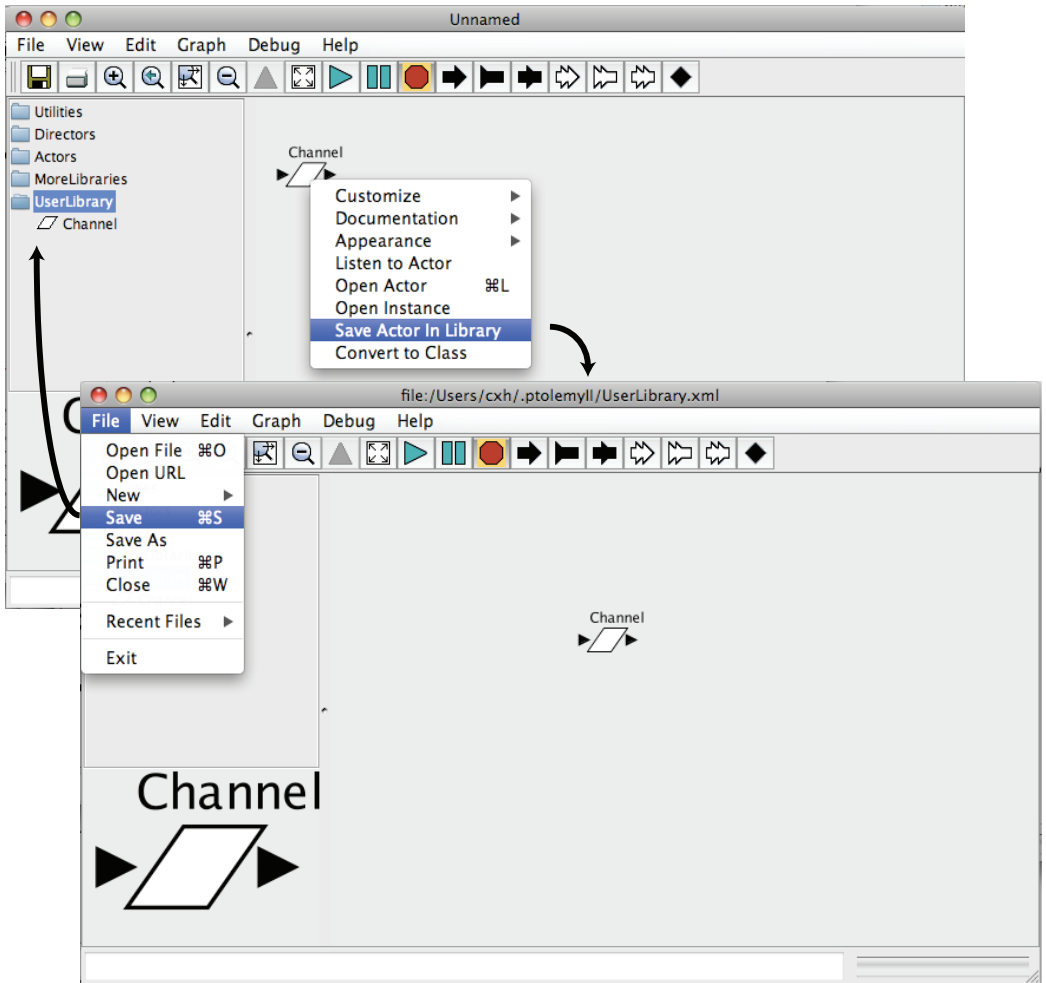

Figure 2.39: Instances of a class that are defined in their own files can be made available in the UserLibrary.

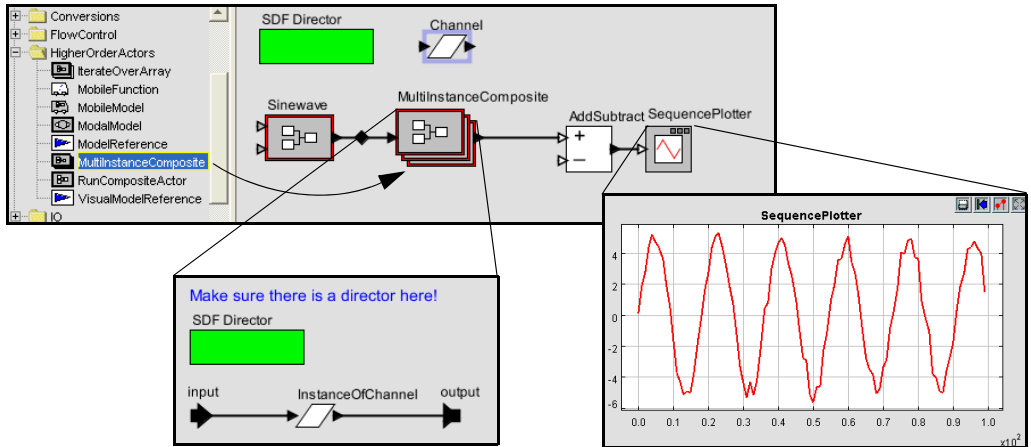

Figure 2.40: A model that is equivalent to that of Figure 2.32, but using a `MultiInstanceComposite`, which permits the number of instances of the channel to change by simply changing one parameter value. [\[online\]](#)

instance of the `Channel` (by creating an instance of the `Channel`, then copying and pasting it into the composite). `MultiInstanceComposite` is required to be *opaque* (meaning that it contains a director). It functions within the model as a single actor, but internally it is realized as a multiplicity of actors operating in parallel.

The `MultiInstanceComposite` actor has three parameters, *nInstances*, *instance*, and *showClones*, as shown in Figure 2.41. The first of these specifies the number of instances to create. At run time, this actor replicates itself this number of times, connecting the inputs and outputs to the same sources and destinations as the first (prototype) instance. In Figure 2.40, notice that the input of the `MultiInstanceComposite` is connected to a relation (the black diamond), and the output is connected directly to a multiport input of the `AddSubtract` actor. As a consequence, the multiple instances will be connected in a manner similar to Figure 2.32, where the same input value is broadcast to all instances, but distinct output values are supplied to the `AddSubtract` actor.

The model created using multi-instances is better than the original version because the number of instances can be changed with a single parameter. Each instance can be customized as needed by expressing its parameter values in terms of the *instance* parameter of the `MultiInstanceComposite`. Try, for example, making the *noisePower* parameter of

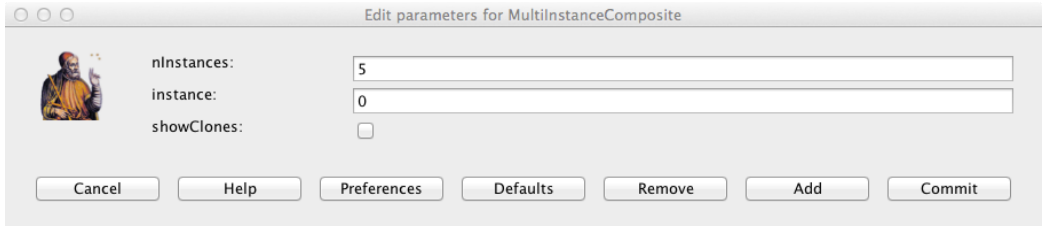

Figure 2.41: The first parameter of the `MultiInstanceComposite` specifies the number of instances. The second parameter is available to the model builder to identify individual instances. The third parameter controls whether the instances are rendered on the screen (when the model is run).

the `InstanceOfChannel` actor in Figure 2.40 depend on *instance*. For example, set it to $instance * 0.1$ and then set *nInstances* to 1. You will see a clean sine wave when you run the model, because the one instance has number zero, so there will be no noise for that instance.

2.7.2 IterateOverArray

The implementation of the `Channel` class, which is shown in Figure 2.37, does not have any state, meaning that an invocation of the `Channel` model does not depend on data calculated in a previous invocation. As a consequence, it is not necessary to use n distinct instances of the `Channel` class to realize a diversity communication system; a single instance could be invoked n times on n copies of the data. This approach can be accomplished by using the **IterateOverArray** higher-order actor.

The `IterateOverArray` actor can be used in a manner similar to the `MultiInstanceComposite` in the previous section. That is, we can populate it with an instance of the `Channel` class, similar to Figure 2.40. The `IterateOverArray` actor also requires a director inside the model.

Example 2.2: Consider the example in Figure 2.42. In this case, the top-level model uses an array with multiple copies of the channel input rather than using a relation to broadcast the input to multiple instances of the channel.

This is accomplished using a combination of the [Repeat](#) actor (found in the `FlowControl`→`SequenceControl` sublibrary) and the [SequenceToArray](#) actor (see box on page 86). The Repeat actor has a parameter, *numberOfTimes*, which in Figure 2.42 is set equal to the *diversity* parameter. The SequenceToArray actor has a parameter *arrayLength* that has also been set to be equal to *diversity* (this parameter can also be set via the *arrayLength* port, which is filled in gray to indicate that it is both a parameter and a port). The output is sent to an [ArrayAverage](#) actor (see box on page 88).

The execution of the model in Figure 2.42 is similar to that of the earlier version, except that the scale of the output is different, reflecting the fact that the output is an average rather than a sum.

The IterateOverArray actor simply executes whatever actor it contains repeatedly on each element of an input array. The actor that it contains can be, as shown in Figure 2.42, an opaque composite actor. Interestingly, however, it can also be an [atomic actor](#). To

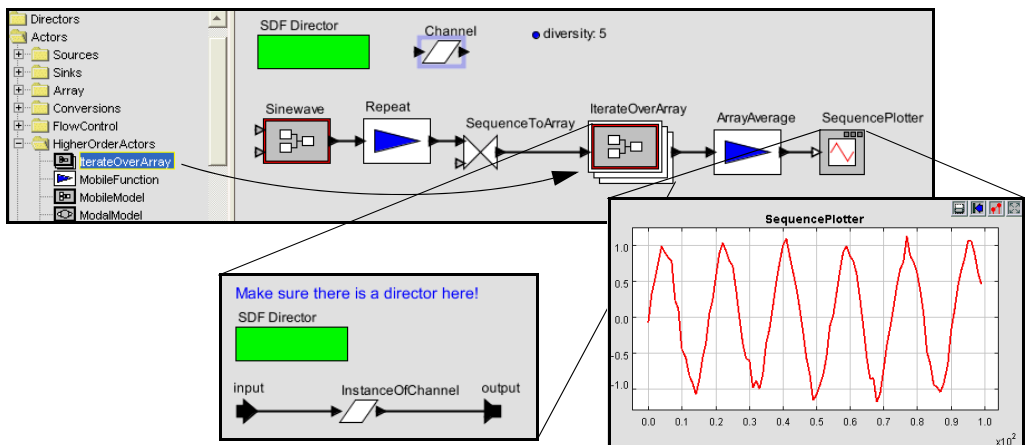

Figure 2.42: The IterateOverArray actor can be used to accomplish the same diversity channel model as in Figure 2.40, but without creating multiple instances of the channel model. This approach is possible because the channel model has no state. [[online](#)]

use an atomic actor with `IterateOverArray`, simply drag and drop the atomic actor onto an instance of `IterateOverArray`. It will then execute that atomic actor on each element of the input array, and produce as output the array of the results. This mechanism is illustrated in Figure 2.43. When an actor is dragged from the library and moved over the `IterateOverArray` actor, the icon acquires a white halo. The halo indicates that if the actor is dropped, it will be dropped into the actor under the cursor, rather than onto the model containing that actor. The actor you drop onto the `IterateOverArray` will become the actor that is executed for each element of the input array. In order for this to work with the `Channel` actor we defined above, however, we need to convert the `Channel` actor into an `opaque` actor by inserting a director, because `IterateOverArray` can only apply opaque actors to array elements.

2.7.3 Lifecycle Management Actors

A few actors in `HigherOrderActors` invoke the execution of a full Ptolemy II model. These actors generally associate ports (created by the user or actor) with parameters of the model. They can be used, for example, to create models that repeatedly run other mod-

Sidebar: Array Construction and Deconstruction Actors

The following actors construct and take apart arrays:

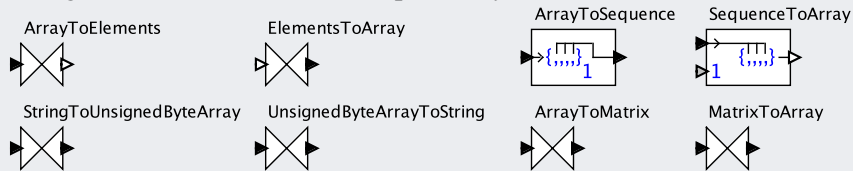

- **ArrayToElements** outputs the elements of an array on channels of the output port.
- **ElementsToArray** constructs an array from elements on channels of the input port.
- **ArrayToSequence** outputs the elements of an array sequentially on the output port.
- **SequenceToArray** constructs an array from a sequence of elements on the input port.
- **StringToUnsignedByteArray** constructs an array from a string.
- **UnsignedByteArrayToString** constructs a string from an array.
- **ArrayToMatrix** constructs a `matrix` from an array.
- **MatrixToArray** constructs an array from a matrix.

In addition, many `polymorphic` actors, such as `AddSubtract`, also operate on arrays.

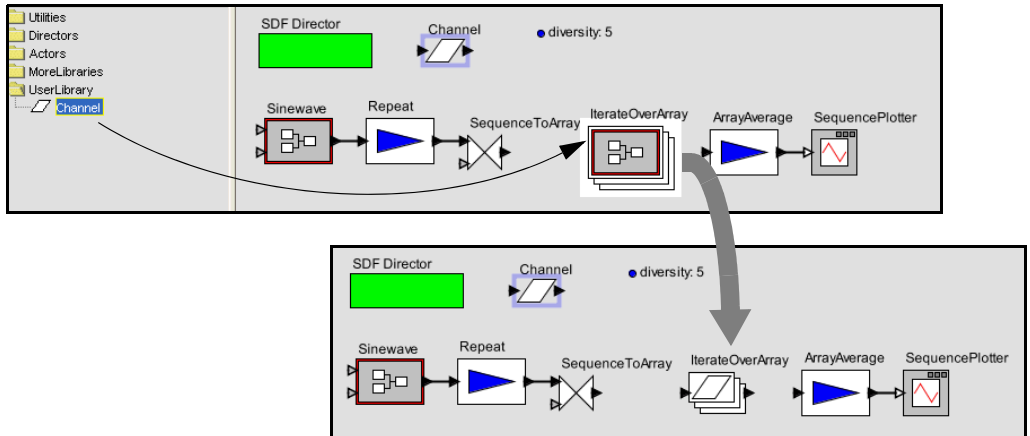

Figure 2.43: The `IterateOverArray` actor supports dropping an actor onto it. It transforms to mimic the icon of the actor you dropped onto it, as shown. Here we are using the `Channel` class, saved to the `UserLibrary` as shown in Figure 2.39.

els with varying parameter values. These include **RunCompositeActor**, which executes the model that it contains. The **ModelReference** actor executes a model that is defined elsewhere in its own file or URL. The **VisualModelReference** actor opens a Vergil view of a model when it executes that model. Additional details can be found in the actor documentation and in the Vergil tour demonstrations.

2.8 Summary

This chapter has introduced Vergil, the visual interface to Ptolemy II, which supports graphical construction of models. Along the way, this chapter has introduced a number of capabilities of the underlying Ptolemy II system. Subsequent chapters will focus on properties of the various directors that are available. The appendices then focus on generic architecture and capabilities that span models of computation.

Sidebar: Array Manipulation Actors

The following actors operate on arrays:

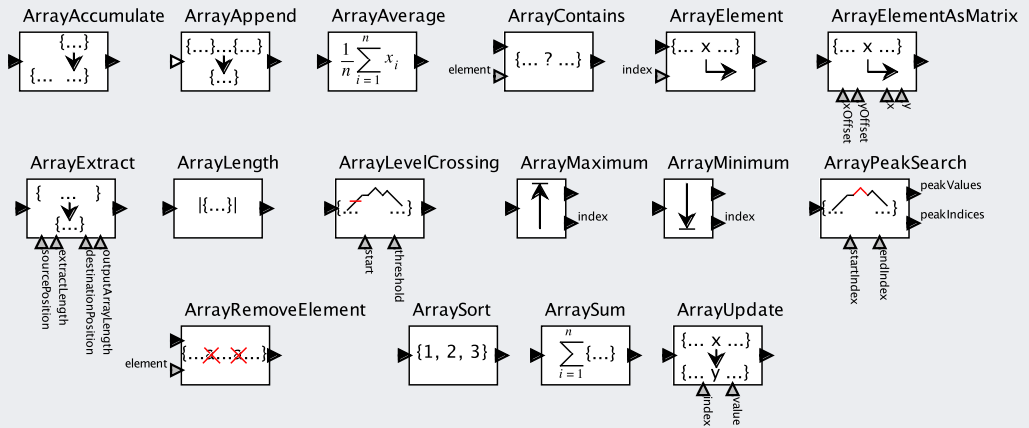

- **ArrayAccumulate** appends input arrays, growing the output array.
- **ArrayAppend** appends input arrays provided on channels of a [multiport](#).
- **ArrayAverage** averages the elements of an array.
- **ArrayContains** determines whether an array contains a specified element.
- **ArrayElement** extracts an element from an array.
- **ArrayElementAsMatrix** extracts an element using matrix-like indexing.
- **ArrayExtract** extracts a subarray.
- **ArrayLength** outputs the length of the input array.
- **ArrayLevelCrossing** finds an element that crosses a threshold.
- **ArrayMaximum** finds the largest element of an array.
- **ArrayMinimum** finds the smallest element of an array.
- **ArrayPeakSearch** finds peak values in an array.
- **ArrayRemoveElement** removes instances of a specified element.
- **ArraySort** sorts an array.
- **ArraySum** sums the elements of an array.
- **ArrayUpdate** outputs a new array like the input array, but with an element replaced.

In addition, many [polymorphic](#) actors, such as [AddSubtract](#), also operate on arrays.

Sidebar: Mobile Code

A pair of actors in Ptolemy II support mobile models, where the data sent from one actor to another is a model to be executed rather than data on which a model operates. The **ApplyFunction** actor accepts a function in the expression language (see Chapter 13) at one input port and applies that function to data that arrives at other input ports (which you must create). The **MobileModel** actor accepts a MoML description of a Ptolemy II model at an input port and then executes that model, streaming data from the other input port through it.

A use of the ApplyFunction actor is shown in Figure 2.44. In that model, two functions are provided to the ApplyFunction in an alternating fashion, one that computes x^2 and the other that computes 2^x . These two functions are provided by two instances of the Const actor, found in the Sources→GenericSources sublibrary. The functions are interleaved by the Commutator actor, from the FlowControl→Aggregators sublibrary.

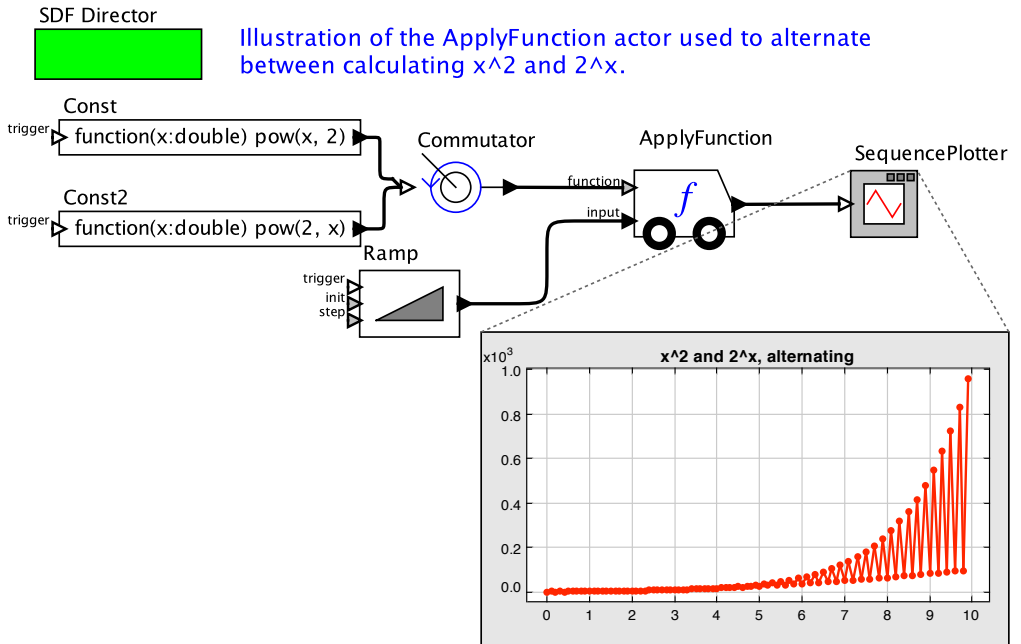

Figure 2.44: The ApplyFunction actor accepts a function definition at one port and applies it to data that arrives at the other port. [[online](#)]